

R04 – Tischablagen für Rahmung für Bereich 1 | 2 und 5

Tischablage für Rahmung R04.B05

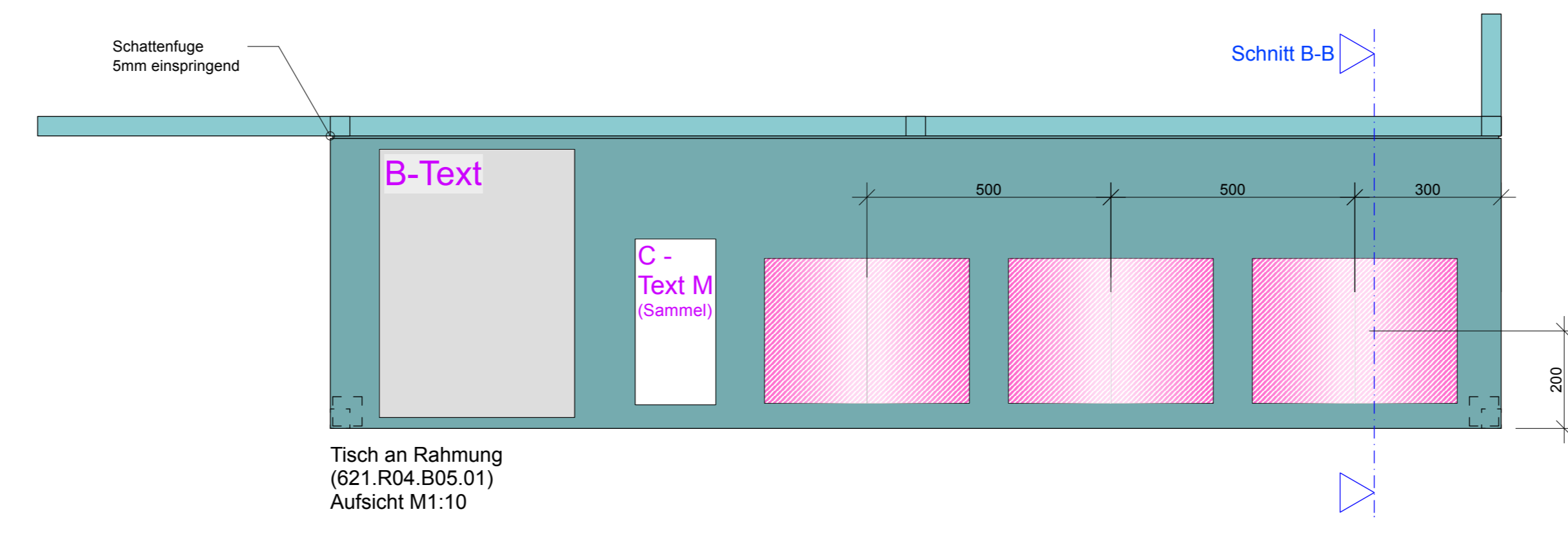

Tischablage für Rahmung R04.B02

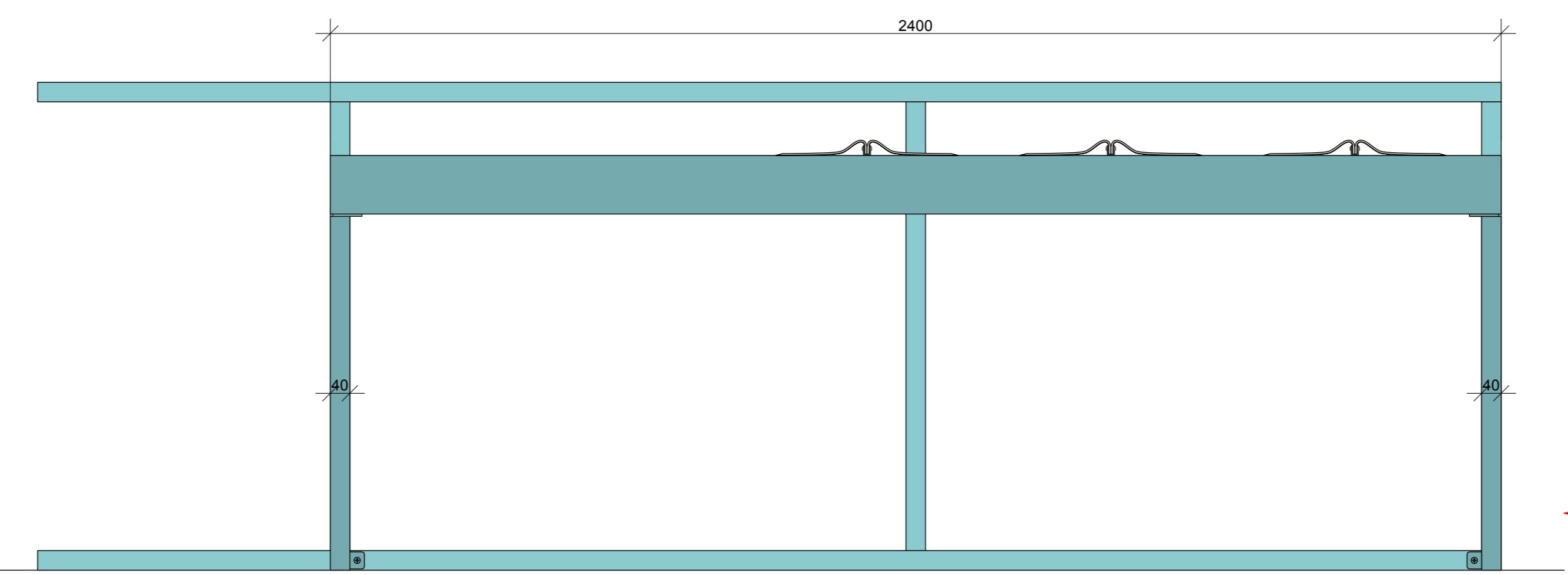
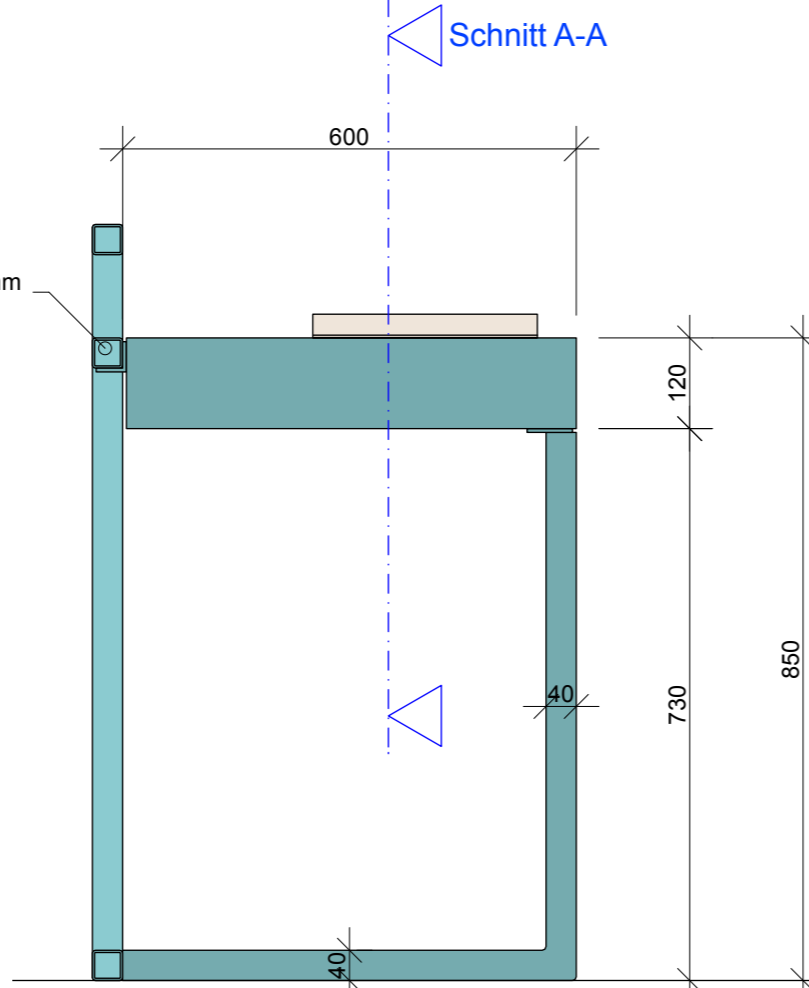
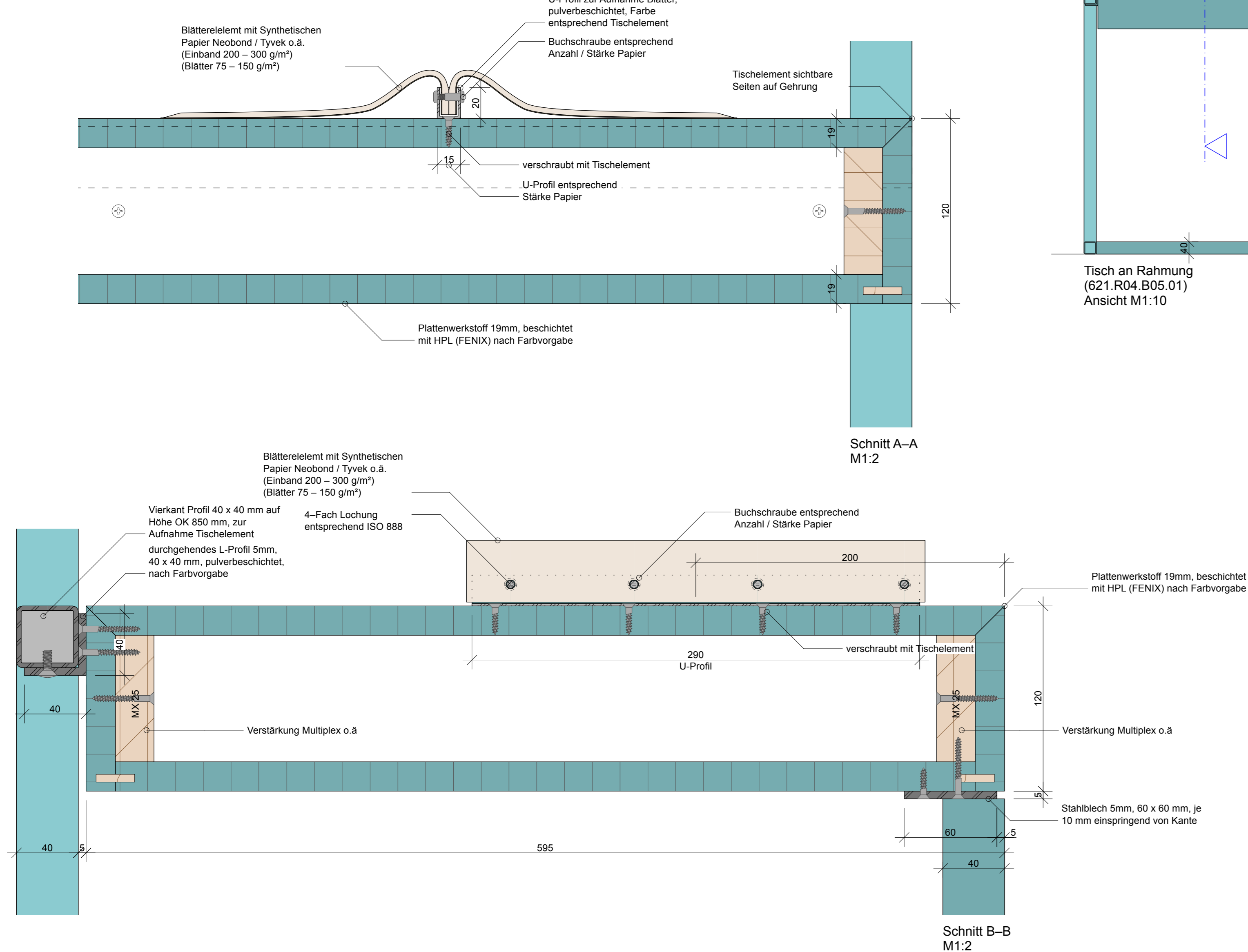
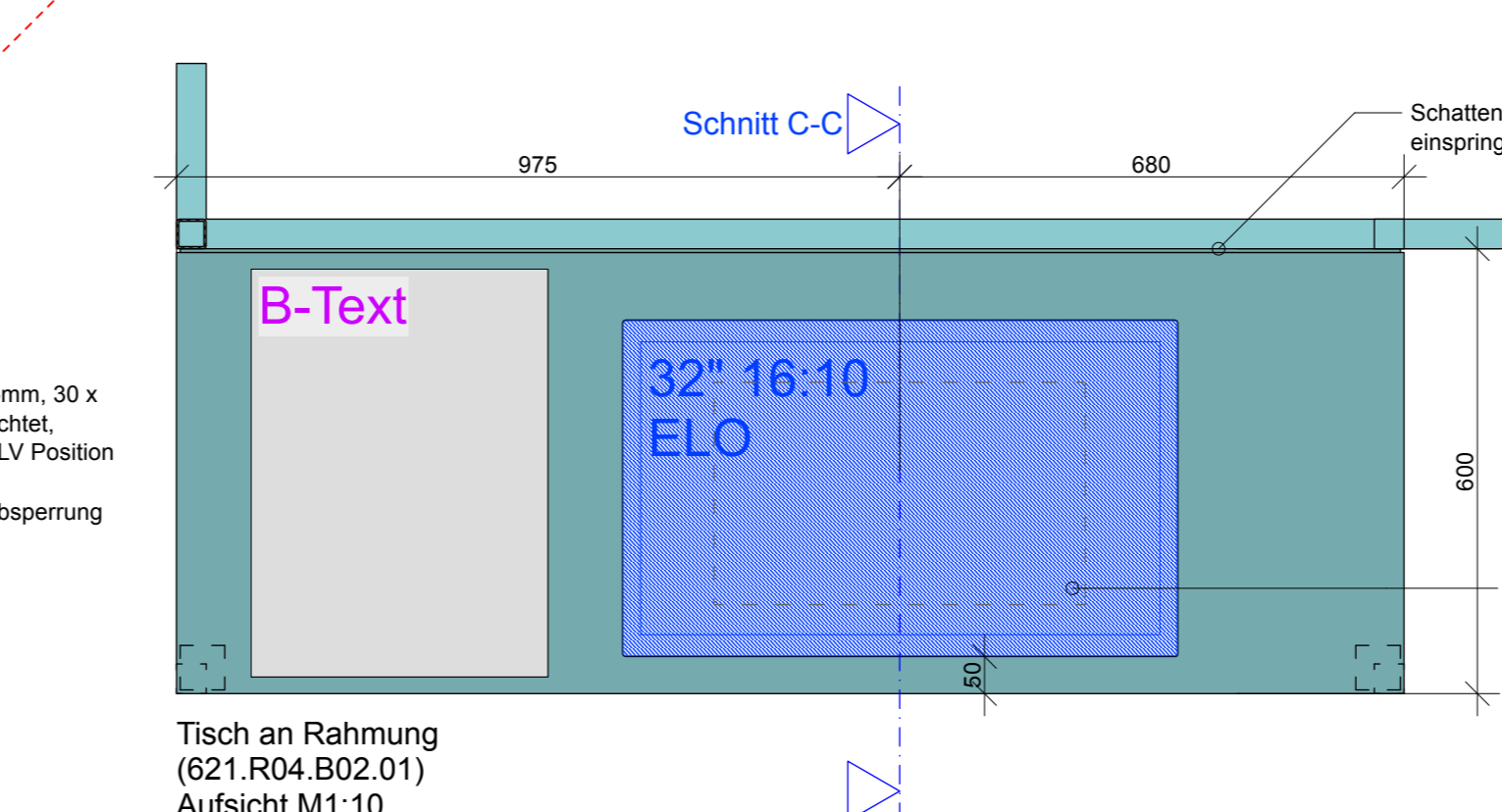
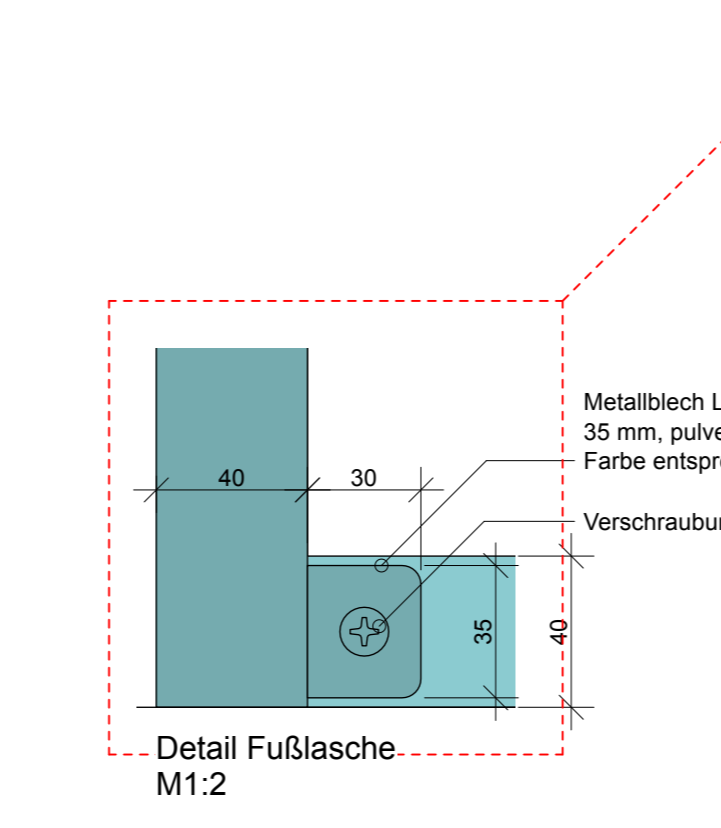
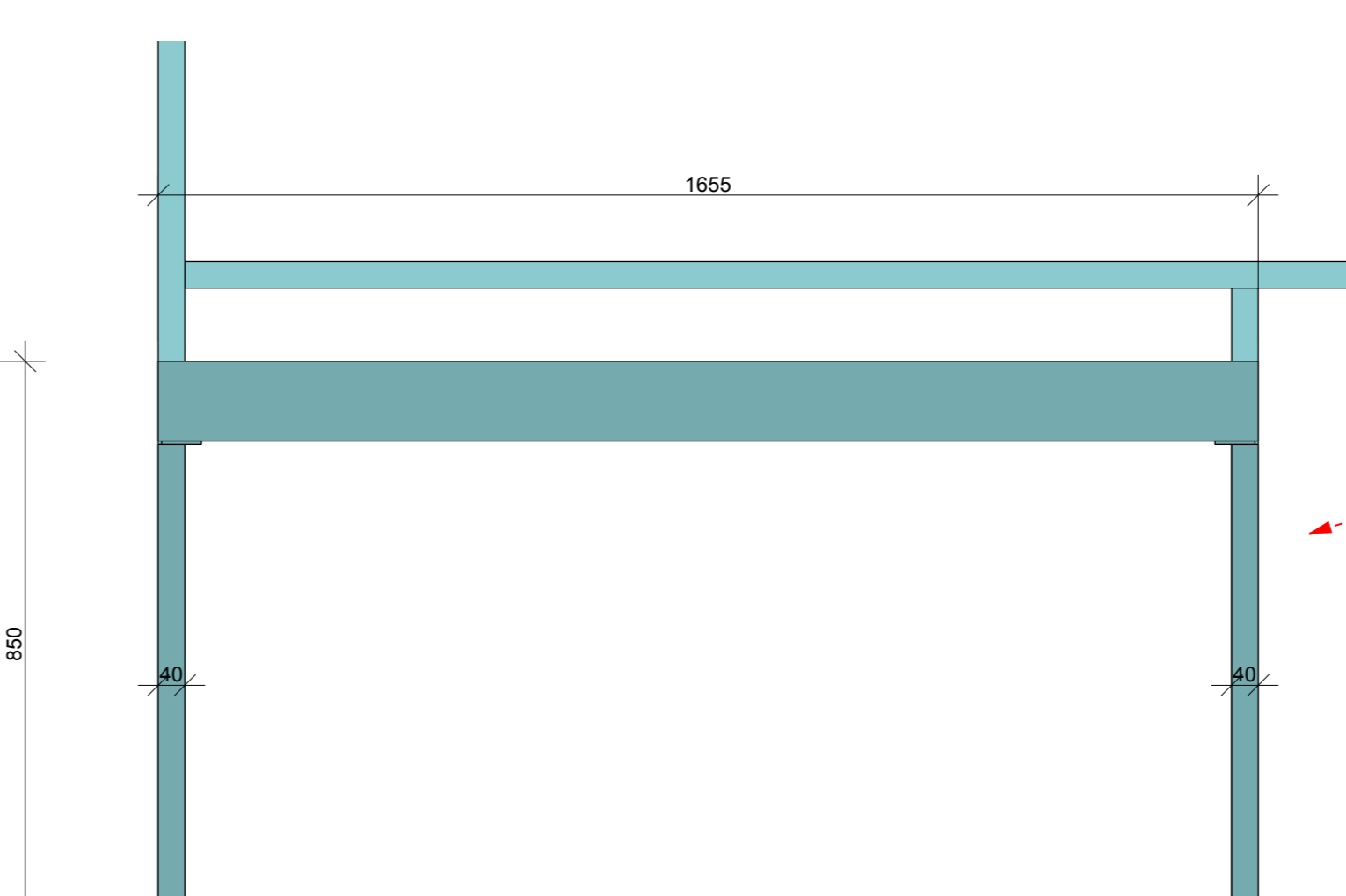
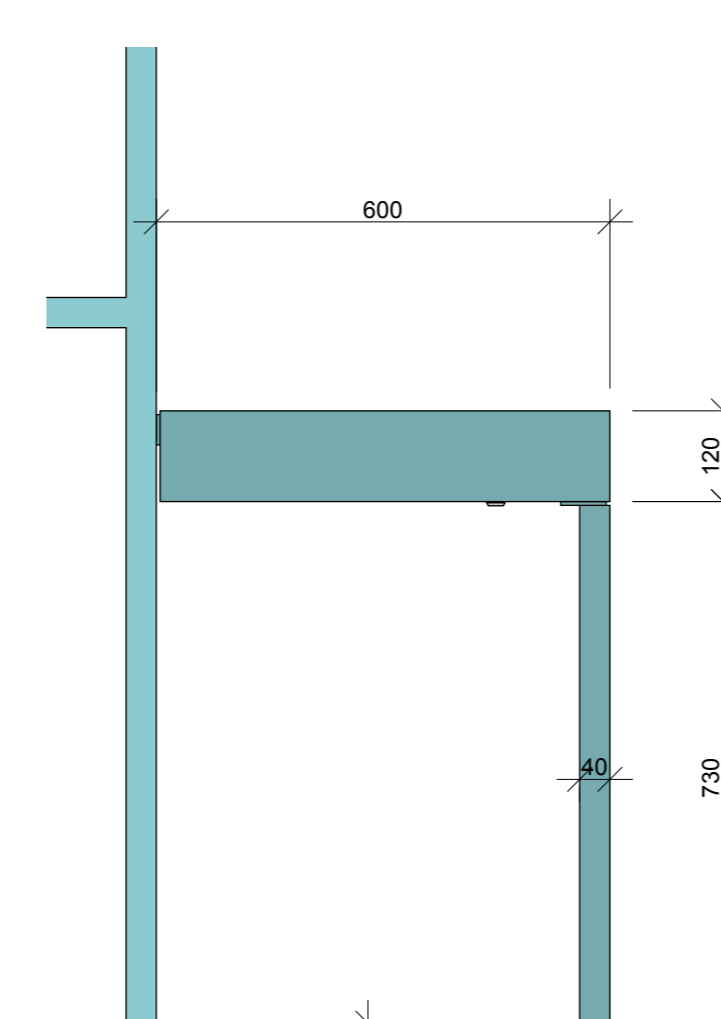
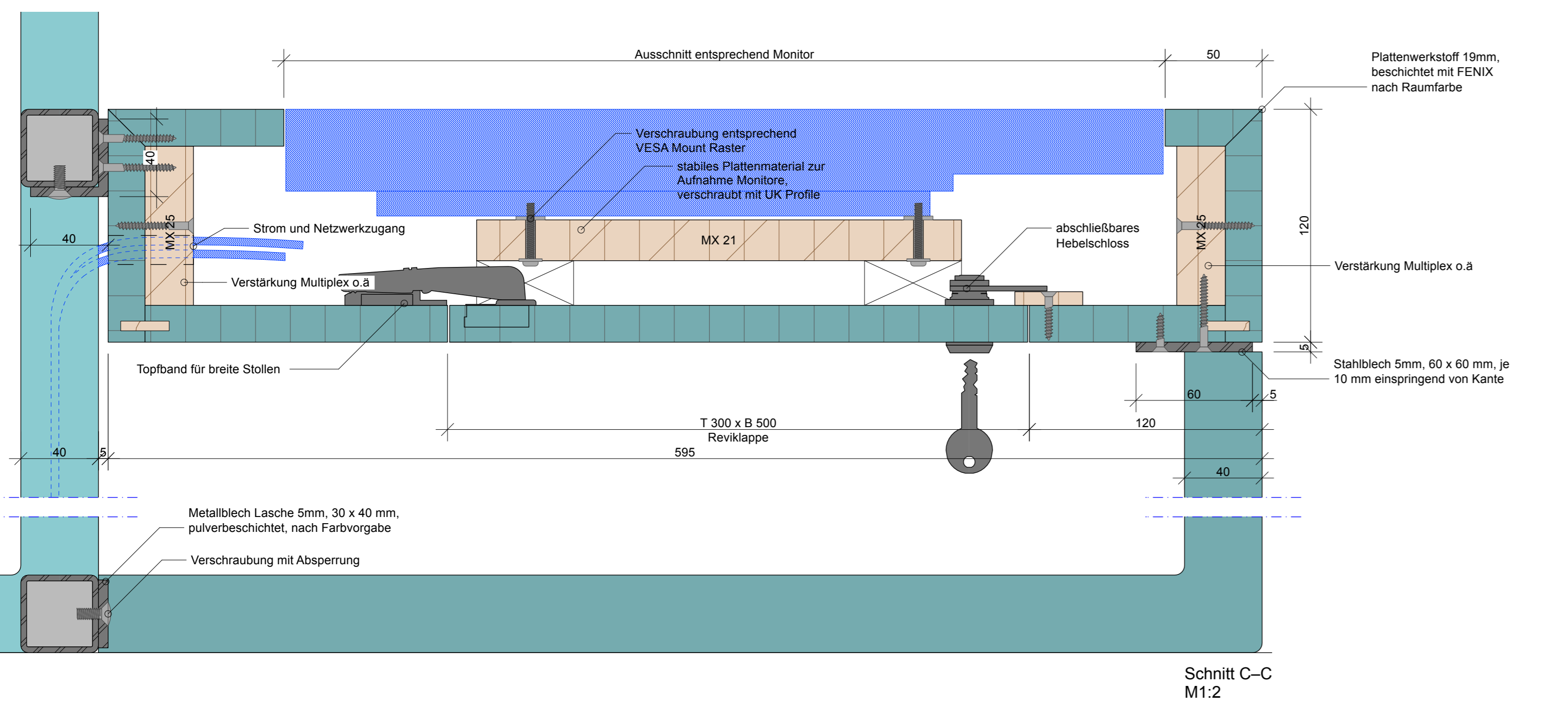

Tischablage für Rahmung R04.B01

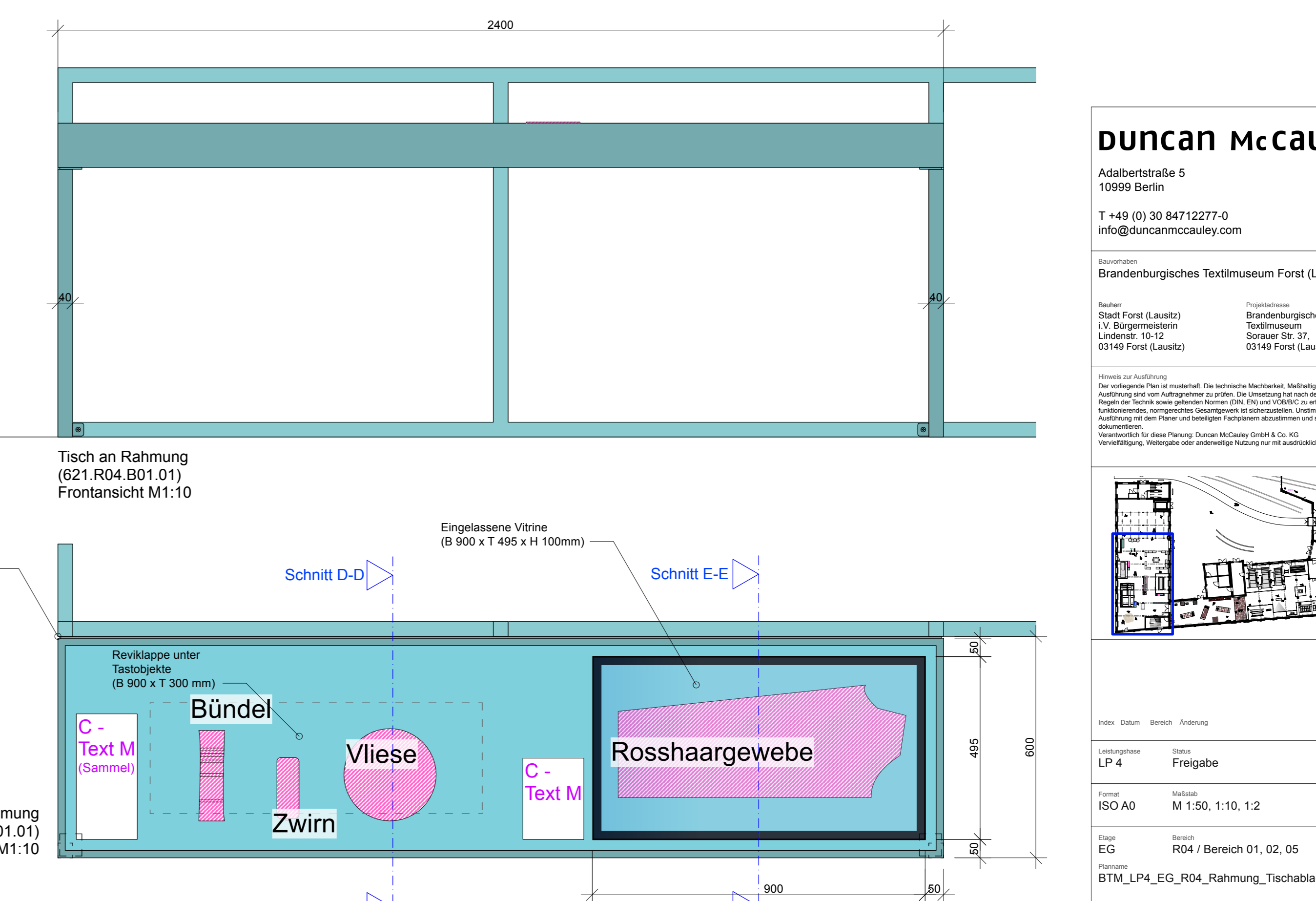
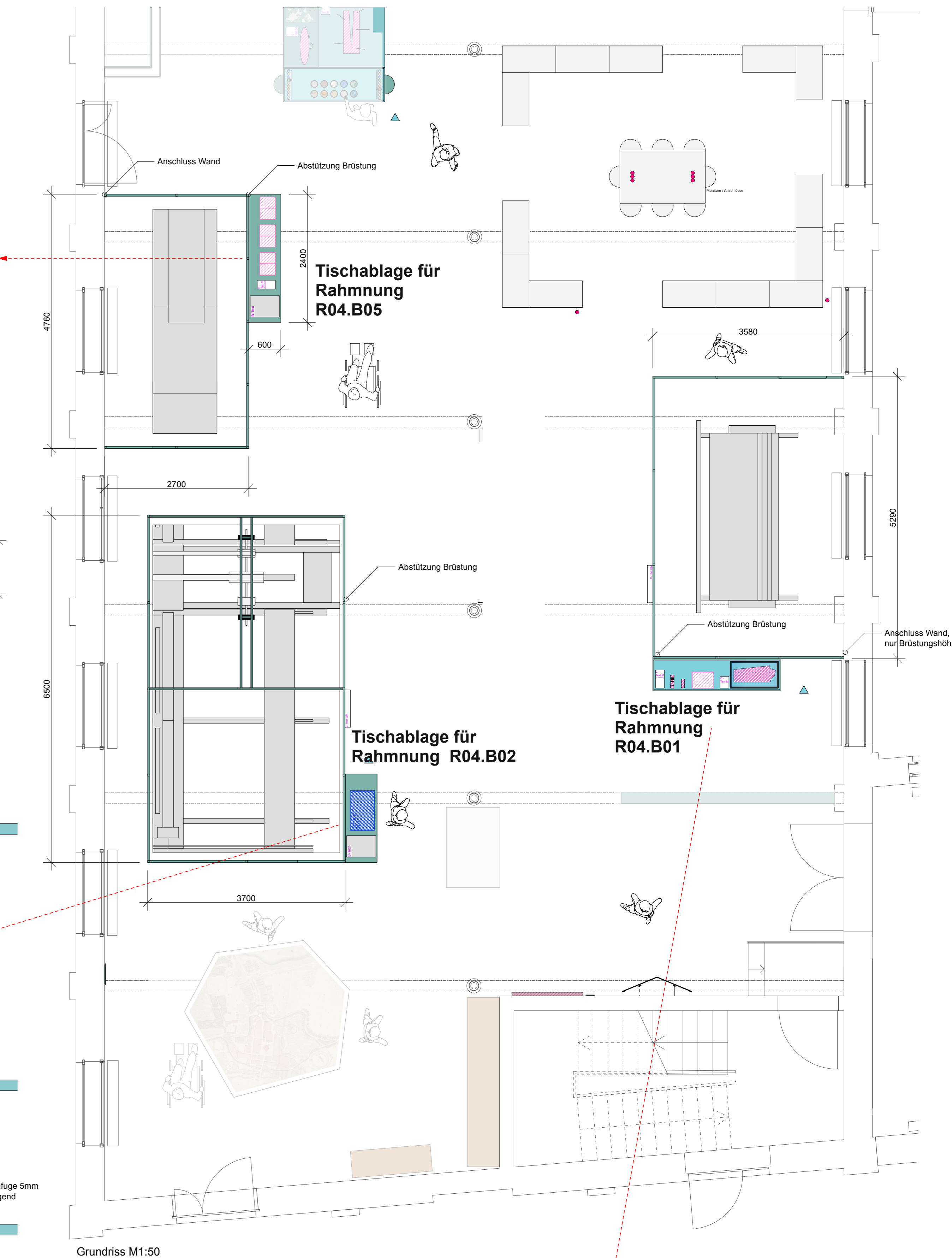
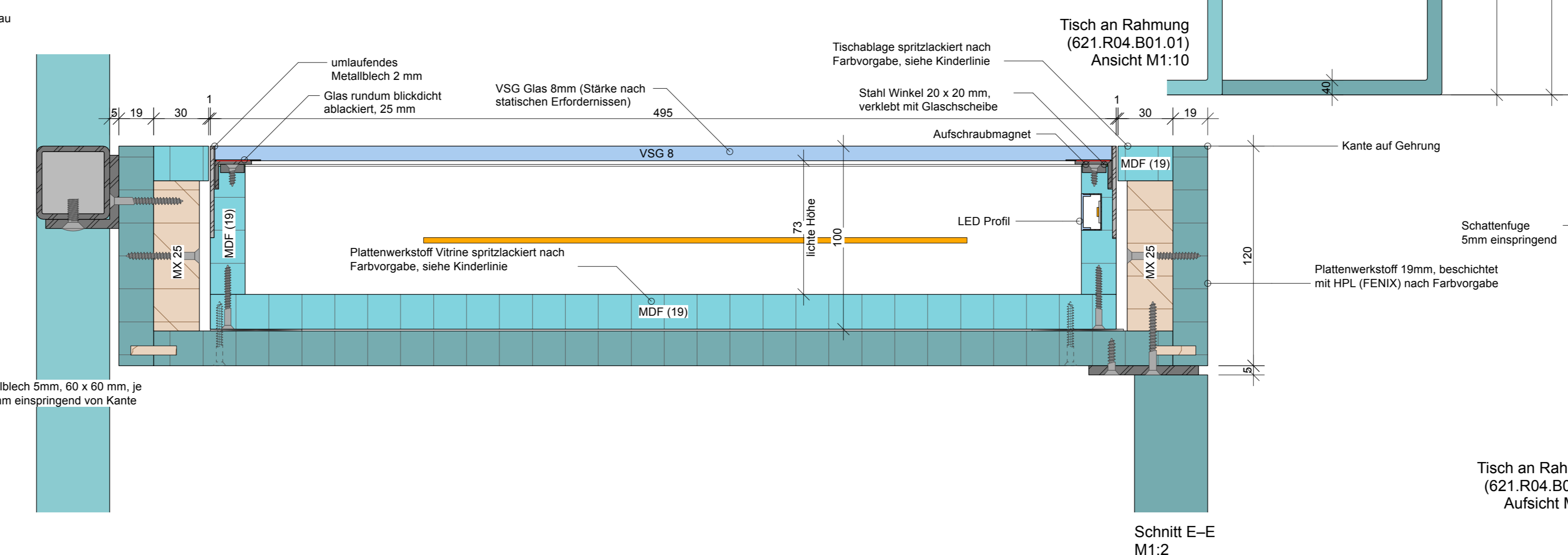
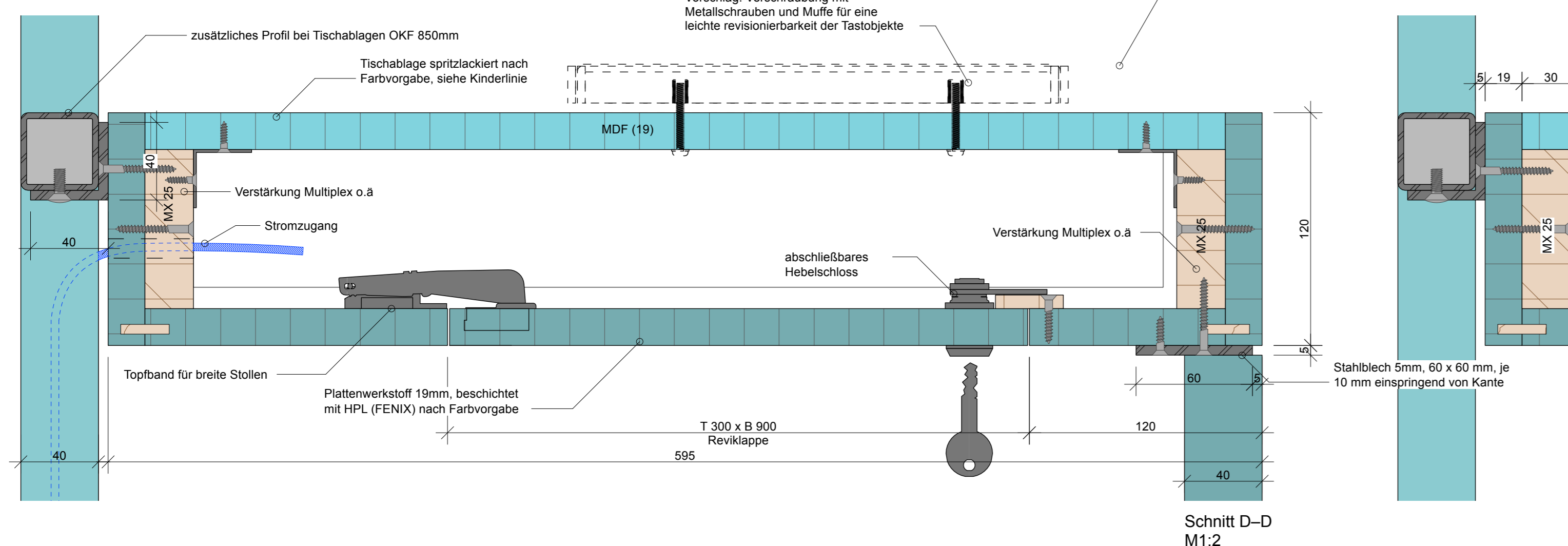

Duncan McCauley
 Adalbertstraße 5
 10999 Berlin
 T +49 (0) 30 84712277-0
 info@duncanmccauley.com

Brandenburgisches Textilmuseum Forst (Lauitz)

Brandenburgisches Textilmuseum
 Standort: 03149 Forst (Lauitz)

11.11.25

1:100

BTM_LP4_EG_R04_Rahmung_Tischablagen