

LP2_Fotodokumentation Achse 5-7

Projekt: 2024A070_Rheinfalzallee 82
Brandschutzsanierung KG
Rheinfalzallee 82, 10318 Berlin, DE

Bauherr: Bundesanstalt für Immobilienaufgaben
Fasanenstraße 87
10623 Berlin
Facility Management
BEFM.10318
Herr Sebastian Maier

Planung: KLW Ingenieure GmbH
Epiphanienweg 6
14059 Berlin

Ersteller: Erich Bückner
Datum: 09.01.2026

Inhaltsverzeichnis

01_Achse 5-7	3
<i>Pin #31 – Ansicht 1 - Flurwand</i>	<i>4</i>
<i>Pin #36 – T.04</i>	<i>8</i>
<i>Pin #37 – 009</i>	<i>10</i>
<i>Pin #39 – 013</i>	<i>12</i>
<i>Pin #40 – 015</i>	<i>13</i>
<i>Pin #42 – 018a</i>	<i>14</i>
<i>Pin #43 – 018</i>	<i>15</i>
<i>Pin #44 – 020</i>	<i>16</i>
<i>Pin #45 – 022a</i>	<i>17</i>

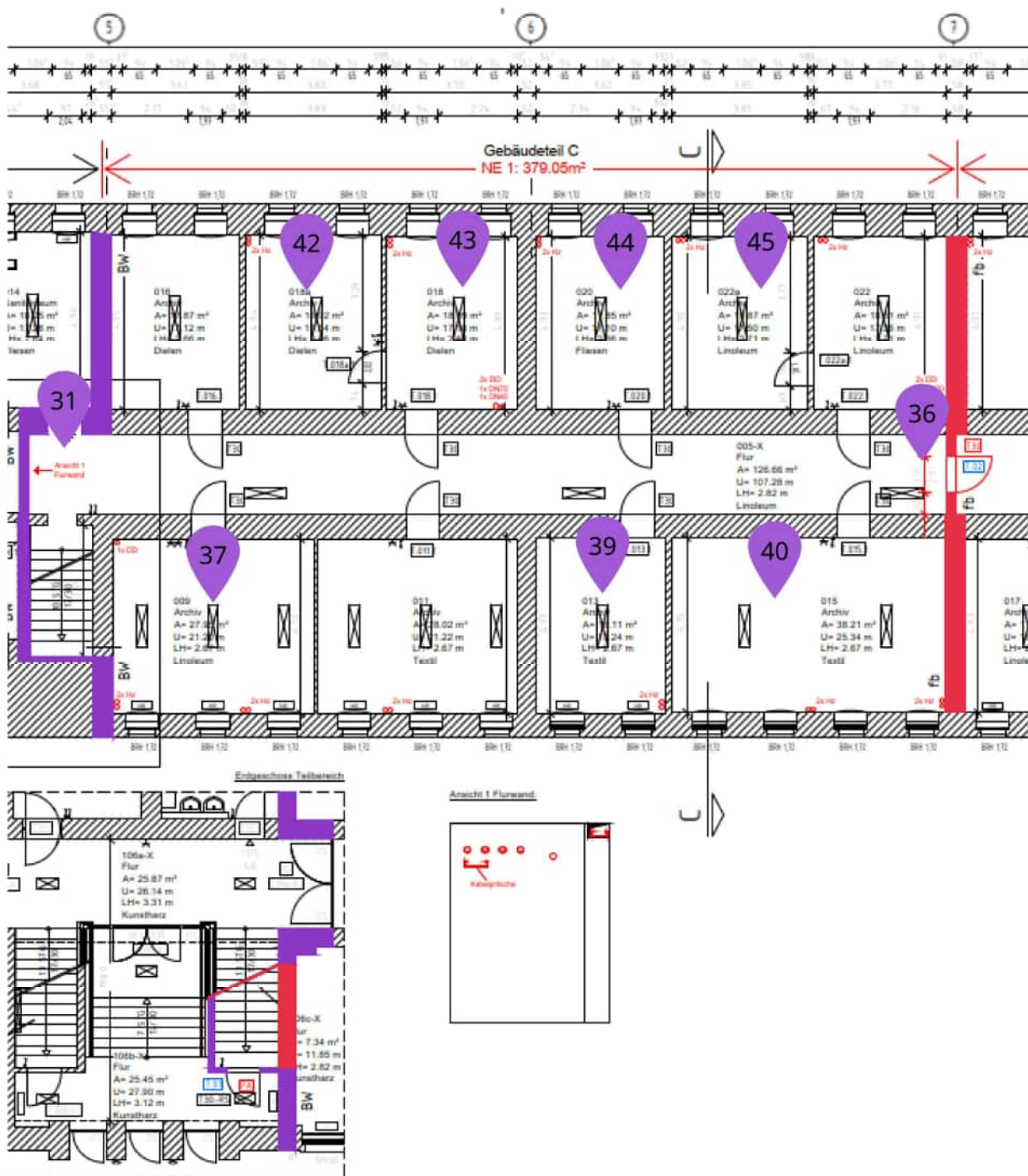

01 / Achse 5 - 7

01_Achse 5-7

Pin #31 – Ansicht 1 - Flurwand

Kategorie: Bestandsaufnahme
Status: Offen

Plan: 01_Achse 5-7 V1
Ersteller: Erich Bucker / 03.07.2025 23:20

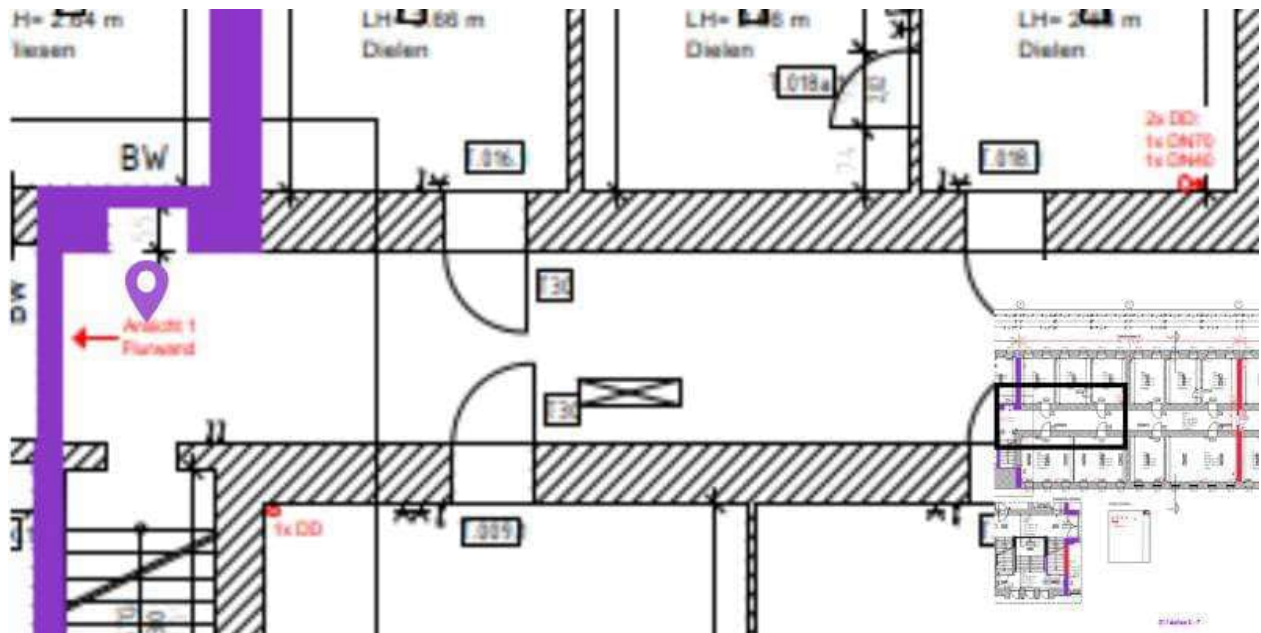

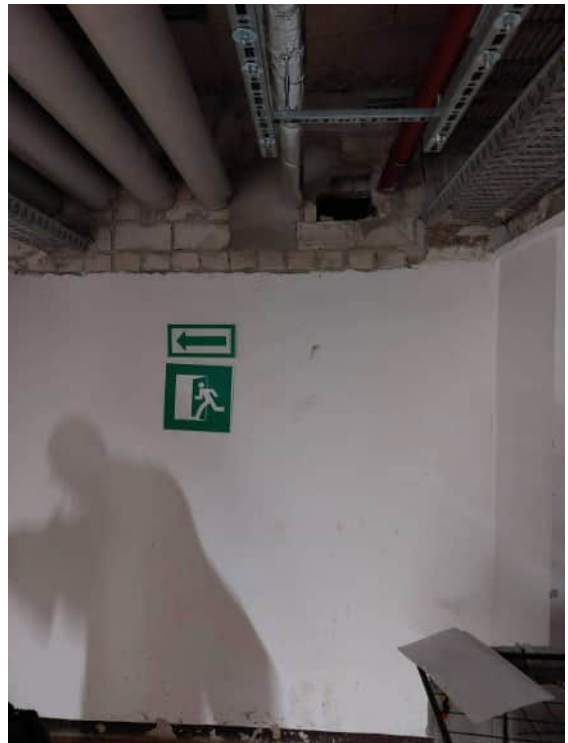



LP2_Fotodokumentation Achse 7-9

Projekt: 2024A070_Rheinfalzallee 82
Brandschutzsanierung KG
Rheinfalzallee 82, 10318 Berlin, DE

Bauherr: Bundesanstalt für Immobilienaufgaben
Fasanenstraße 87
10623 Berlin
Facility Management
BEFM.10318
Herr Sebastian Maier

Planung: KLW Ingenieure GmbH
Epiphanienweg 6
14059 Berlin

Ersteller: Erich Bücken
Datum: 09.01.2026

Inhaltsverzeichnis

02_Achse 7-9	3
<i>Pin #34 – Tür ELT-Raum</i>	4
<i>Pin #35 – ELT-Durchführung</i>	5
<i>Pin #49 – 024</i>	6
<i>Pin #50 – 024a</i>	8
<i>Pin #51 – 026</i>	9
<i>Pin #52 – 026a</i>	10
<i>Pin #53 – 026b</i>	12
<i>Pin #54 – 023</i>	14
<i>Pin #55 – 021a</i>	15

Pin #34 – Tür ELT-Raum

Kategorie: Bestandsaufnahme
Status: Offen

Plan: 02_Achse 7-9 V2
Ersteller: Erich Bucker / 04.07.2025 00:04

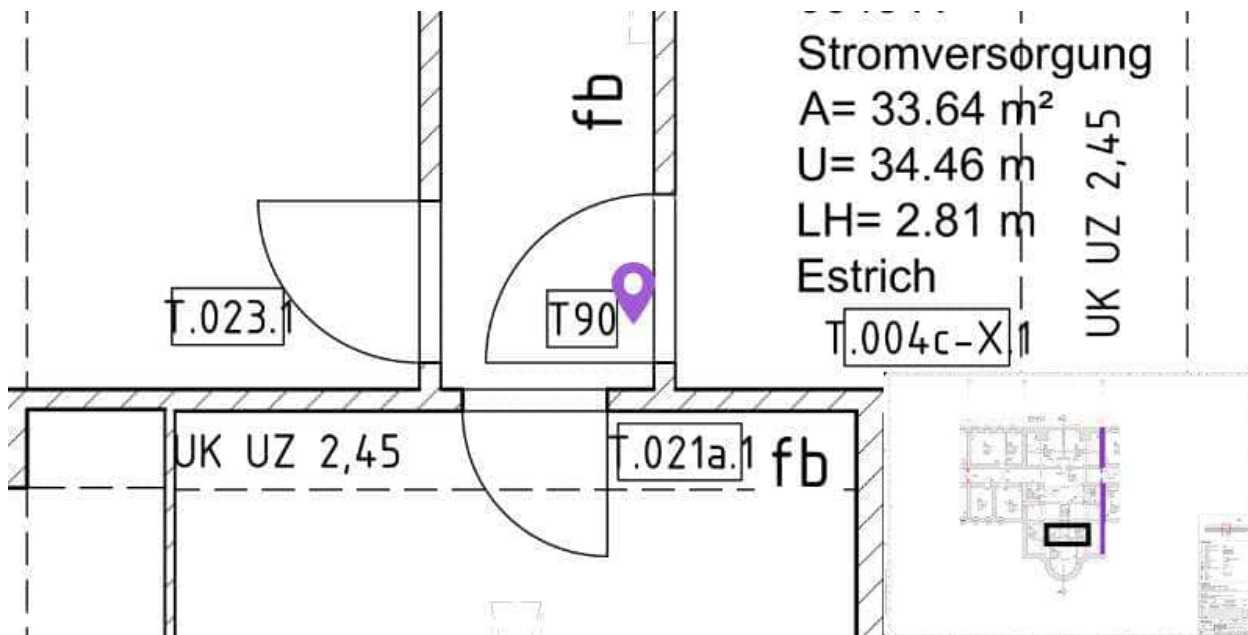

Pin #35 – ELT-Durchführung

Kategorie: Bestandsaufnahme Plan: 02_Achse 7-9 V2
 Status: Offen Ersteller: Erich Bucker / 04.07.2025 00:08

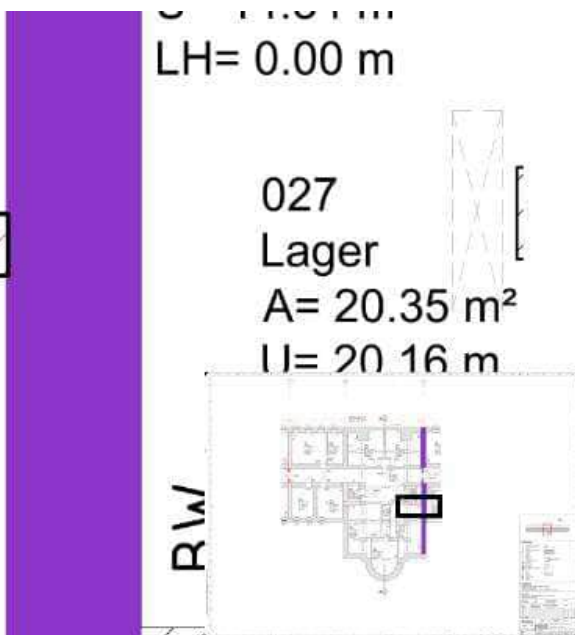
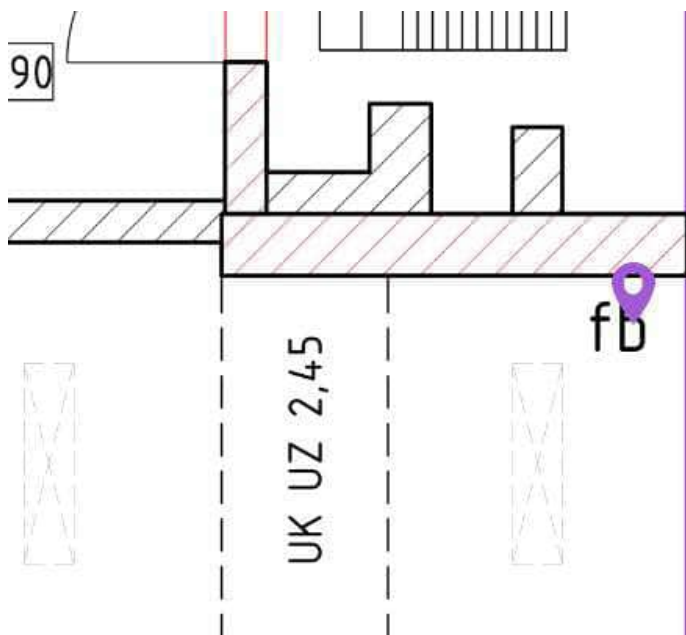

Schottung überprüfen
 03.07.2025

Pin #49 – 024

Kategorie: Bestandsaufnahme
Status: Offen

Plan: 02_Achse 7-9 V2
Ersteller: Erich Bucker / 05.07.2025 20:37





Pin #50 – 024a

Kategorie: Bestandsaufnahme
Status: Offen

Plan: 02_Achse 7-9 V2
Ersteller: Erich Bucker / 05.07.2025 20:43

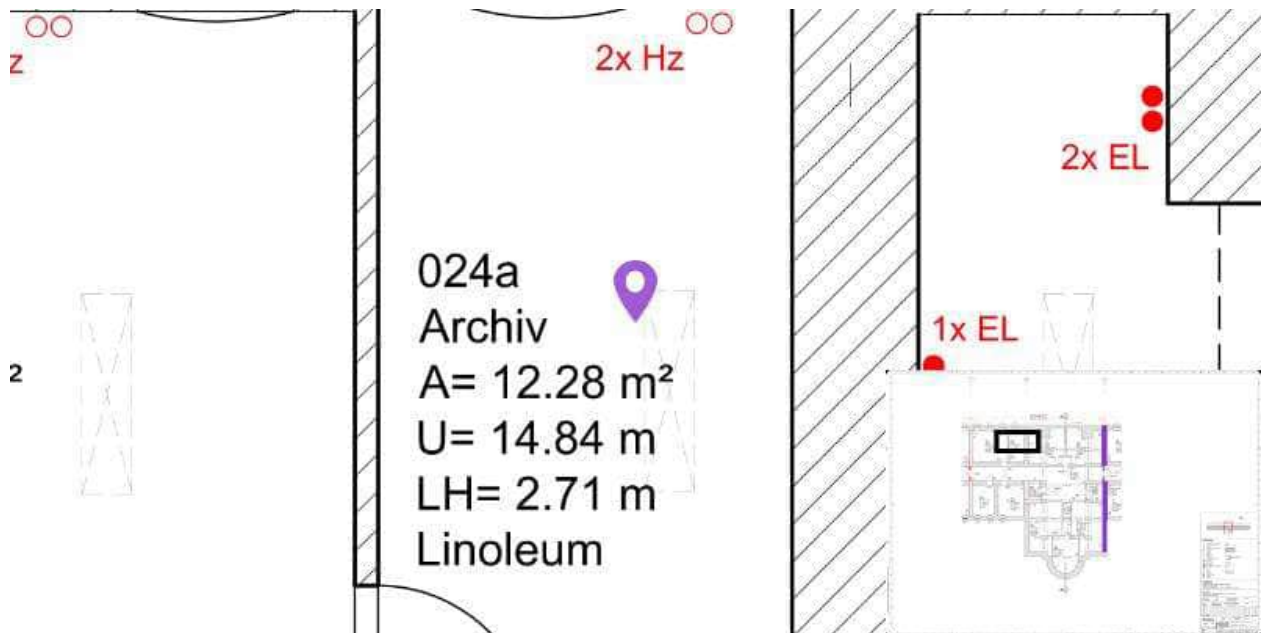

Pin #51 – 026

Kategorie: Bestandsaufnahme
Status: Offen

Plan: 02_Achse 7-9 V2
Ersteller: Erich Bucker / 05.07.2025 20:44

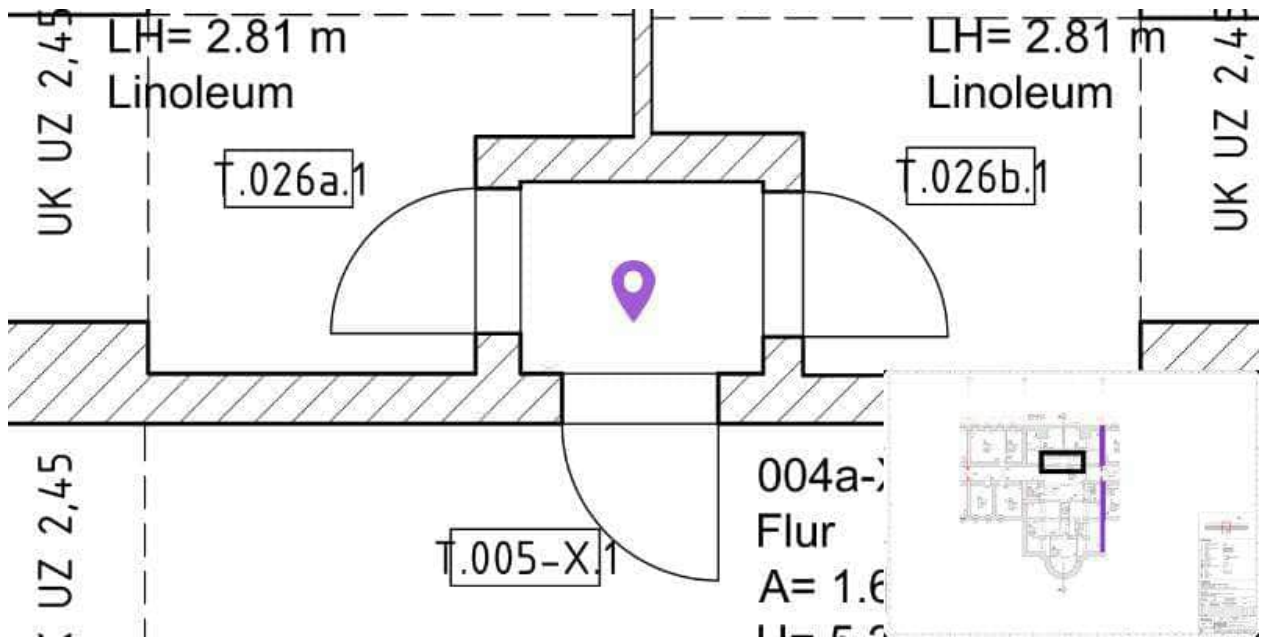

Pin #52 – 026a

Kategorie: Bestandsaufnahme
Status: Offen

Plan: 02_Achse 7-9 V2
Ersteller: Erich Bucker / 05.07.2025 21:01

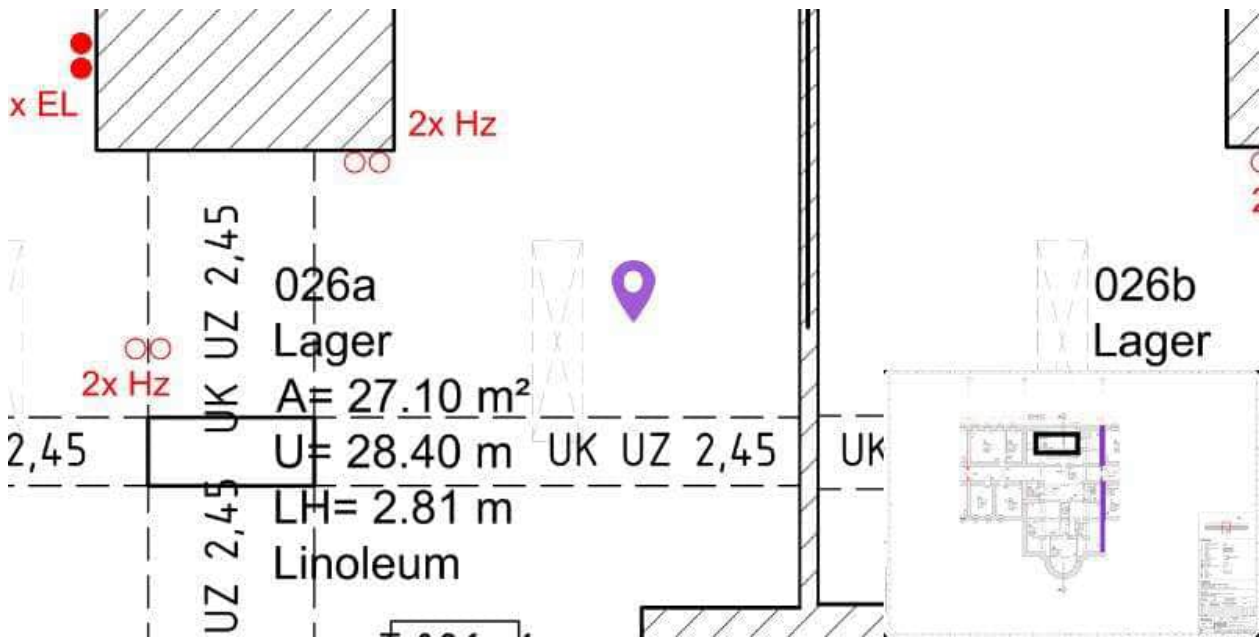





Pin #54 – 023

Kategorie: Bestandsaufnahme
Status: Offen

Plan: 02_Achse 7-9 V2
Ersteller: Erich Bucker / 05.07.2025 21:46



Pin #55 – 021a

Kategorie: Bestandsaufnahme
Status: Offen

Plan: 02_Achse 7-9 V2
Ersteller: Erich Bucker / 05.07.2025 21:50

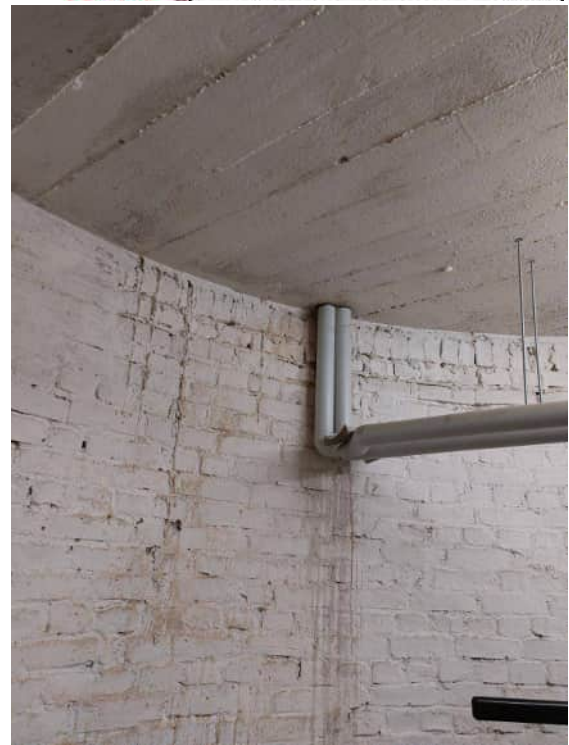
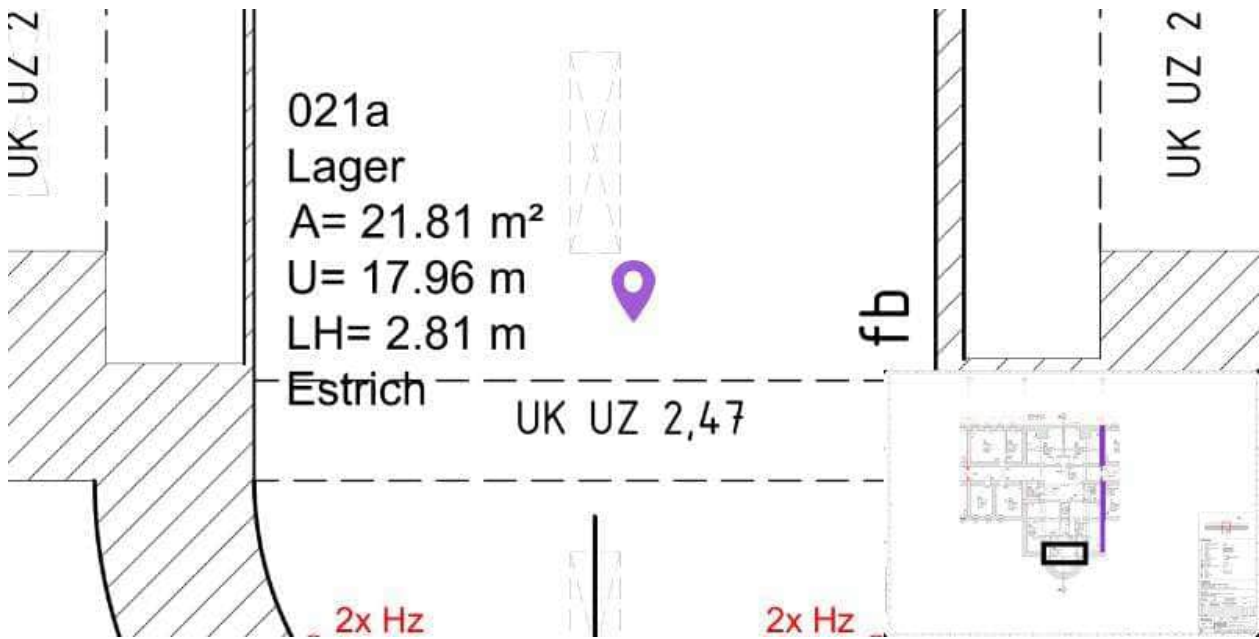



Ansicht 1
03.07.2025

Pin #36 – T.04

Kategorie: Bestandsaufnahme
Status: Offen

Plan: 01_Achse 5-7 V1
Ersteller: Erich Bucker / 04.07.2025 00:17

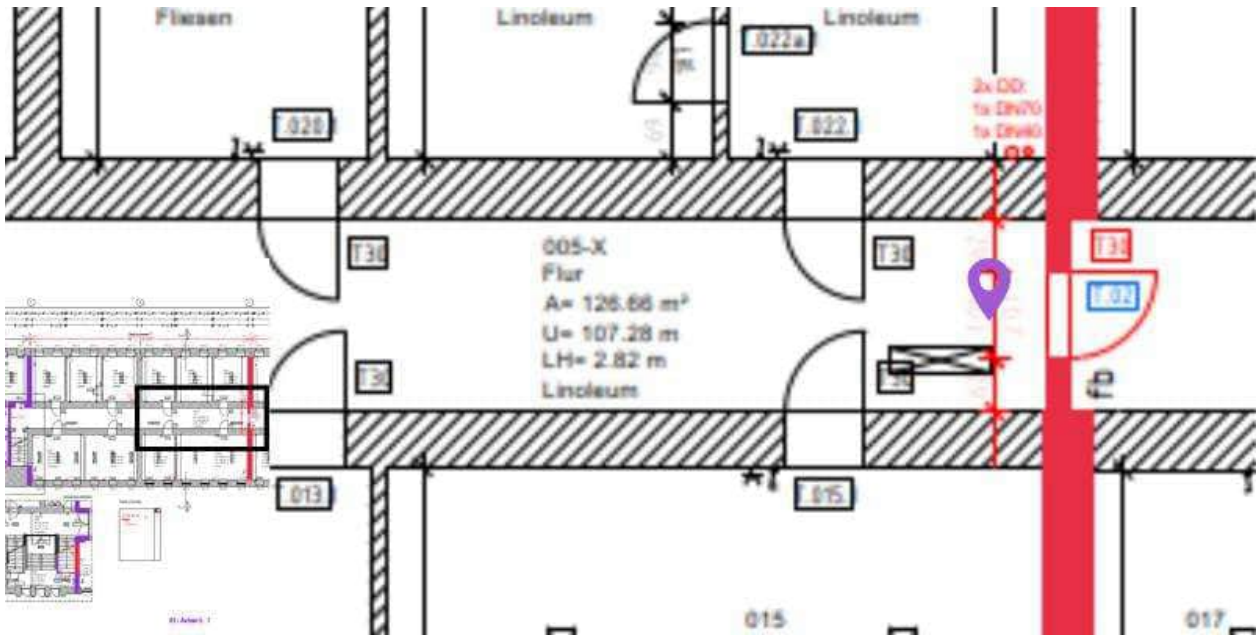





Pin #39 – 013

Kategorie: Bestandsaufnahme
Status: Offen

Plan: 01_Achse 5-7 V1
Ersteller: Erich Bucker / 05.07.2025 00:13

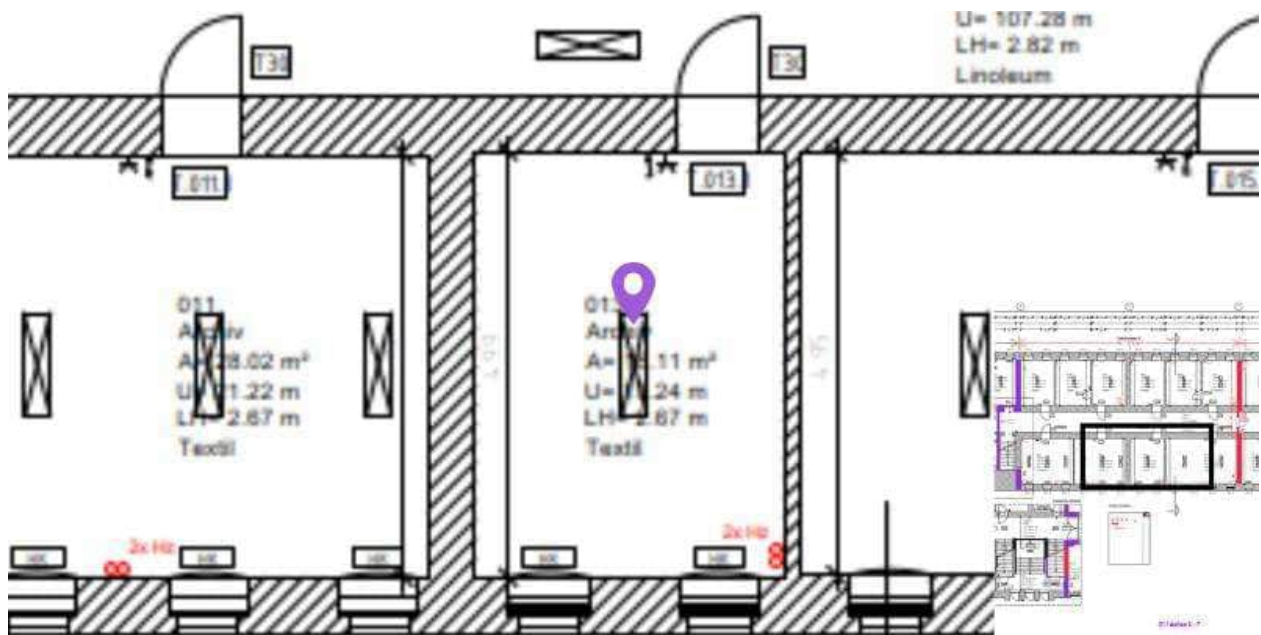

Pin #40 – 015

Kategorie: Bestandsaufnahme
Status: Offen

Plan: 01_Achse 5-7 V1
Ersteller: Erich Bucker / 05.07.2025 00:16

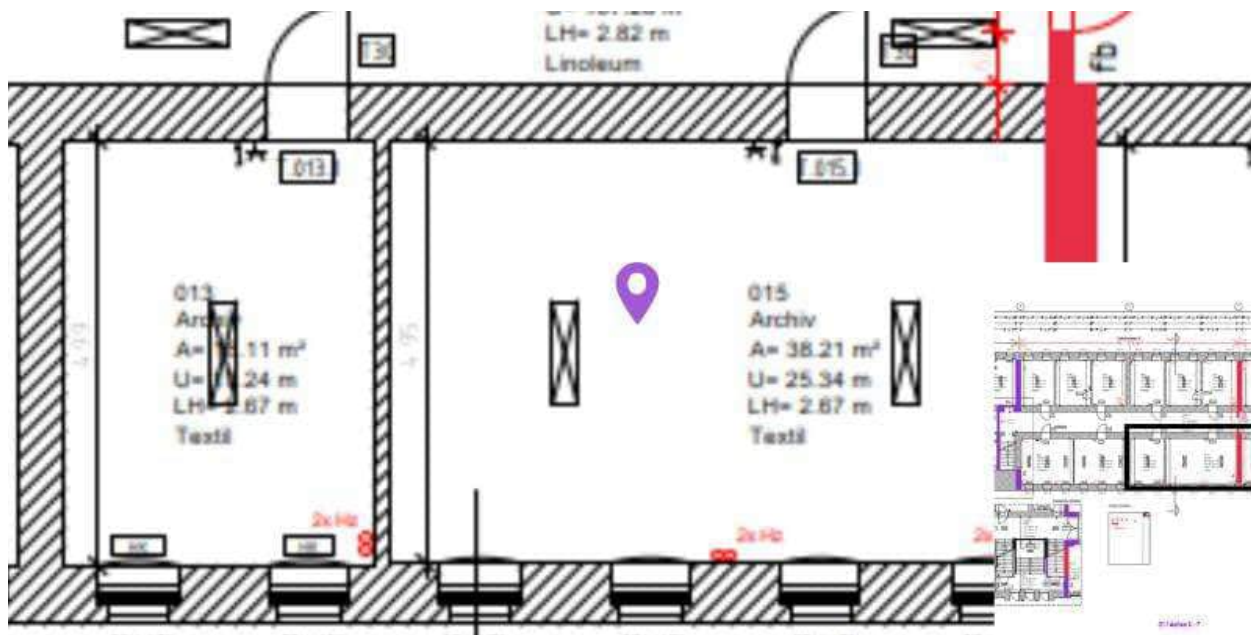

Pin #42 – 018a

Kategorie: Bestandsaufnahme
Status: Offen

Plan: 01_Achse 5-7 V1
Ersteller: Erich Bucker / 05.07.2025 00:23

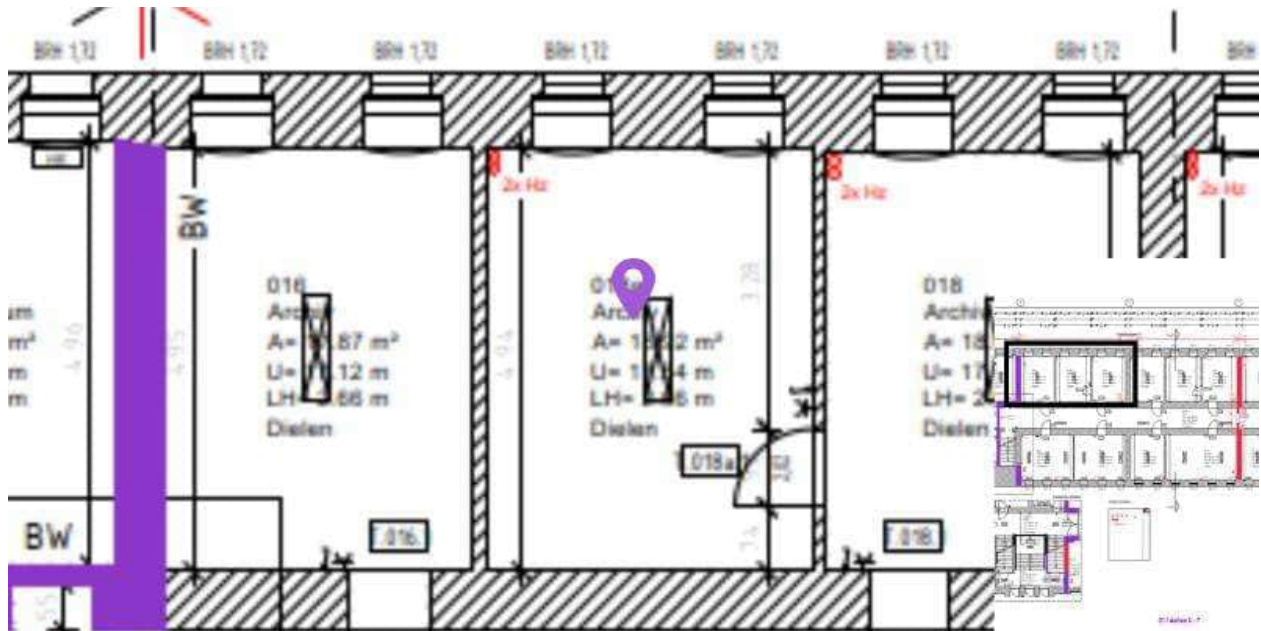

Pin #43 – 018

Kategorie: Bestandsaufnahme
Status: Offen

Plan: 01_Achse 5-7 V1
Ersteller: Erich Bucker / 05.07.2025 00:28

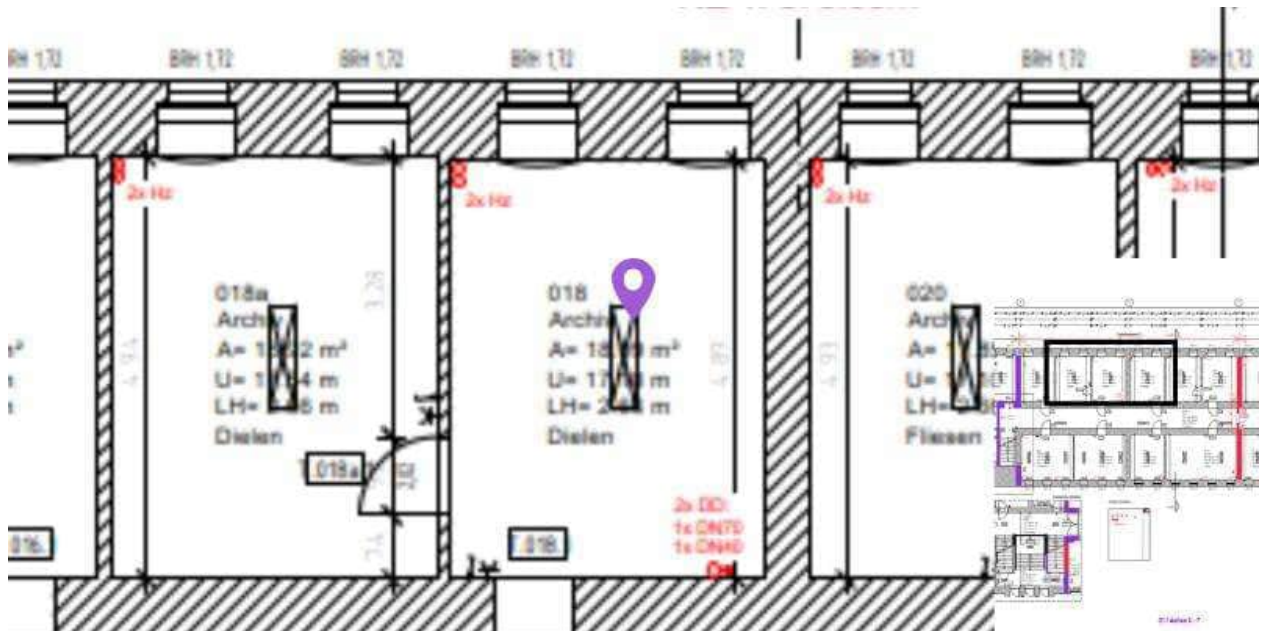

Pin #44 – 020

Kategorie: Bestandsaufnahme
Status: Offen

Plan: 01_Achse 5-7 V1
Ersteller: Erich Bucker / 05.07.2025 00:31

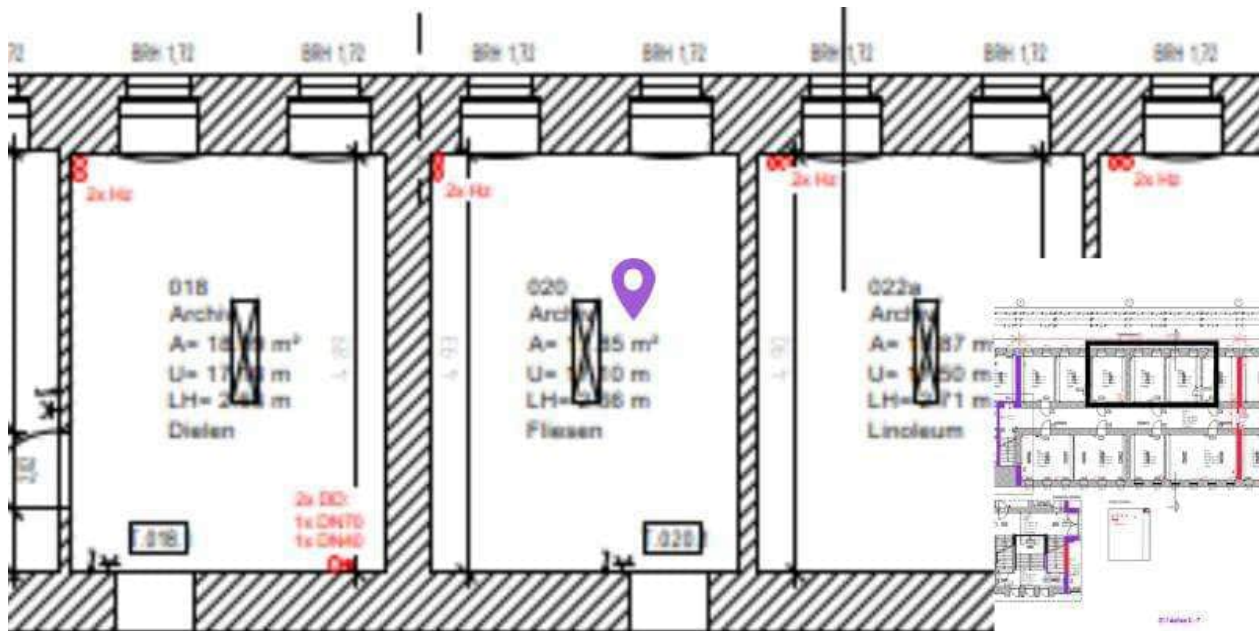

Pin #45 – 022a

Kategorie: Bestandsaufnahme
Status: Offen

Plan: 01_Achse 5-7 V1
Ersteller: Erich Bucker / 05.07.2025 00:33

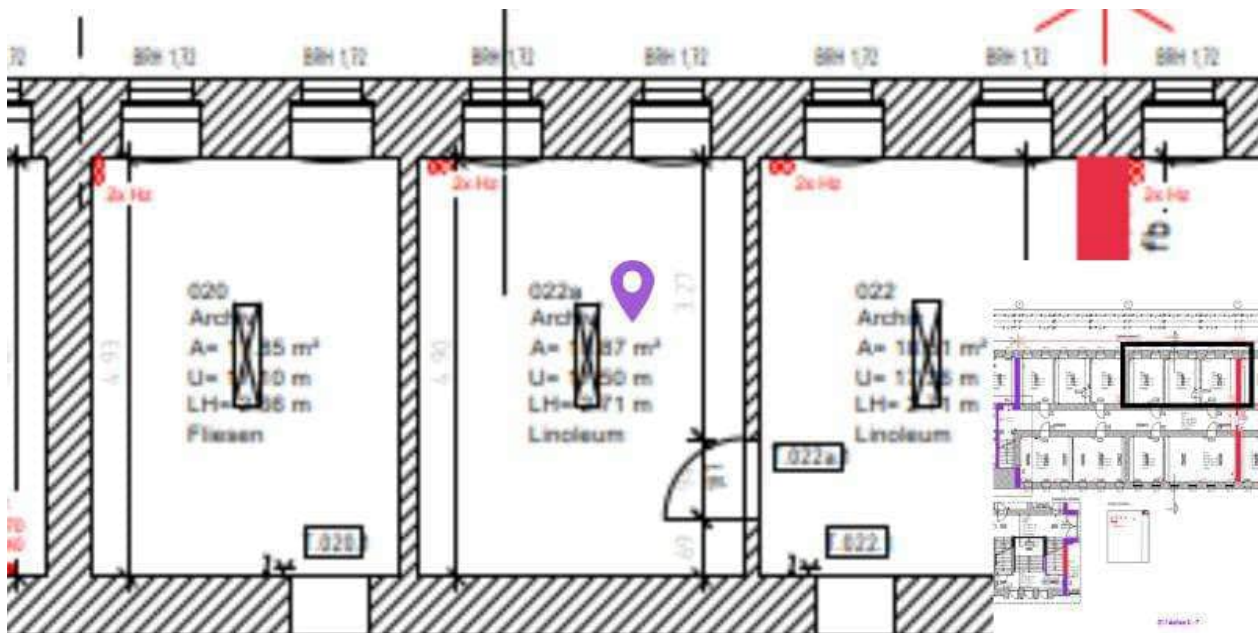

LP2_Fotodokumentation Achse 9-11

Projekt: 2024A070_Rheinpfalzallee 82
Brandschutzsanierung KG
Rheinpfalzallee 82, 10318 Berlin, DE

Bauherr: Bundesanstalt für Immobilienaufgaben
Fasanenstraße 87
10623 Berlin
Facility Management
BEFM.10318
Herr Sebastian Maier

Planung: KLW Ingenieure GmbH
Epiphanienweg 6
14059 Berlin

Ersteller: Erich Bücken
Datum: 09.01.2026

Inhaltsverzeichnis

03_Achse 9-11	3
<i>Pin #10 – 030_1</i>	4
<i>Pin #11 – 030_2</i>	5
<i>Pin #12 – 030_3</i>	6
<i>Pin #13 – 030_4</i>	7
<i>Pin #14 – 030_5</i>	8
<i>Pin #57 – 033a</i>	9
<i>Pin #58 – 033b</i>	10
<i>Pin #59 – 003-X Flur NE3-4</i>	11

Pin #10 – 030_1

Kategorie: Bestandsaufnahme
Status: Offen

Plan: 03_Achse 9-11 V1
Ersteller: Erich Bucker / 25.06.2025 09:14

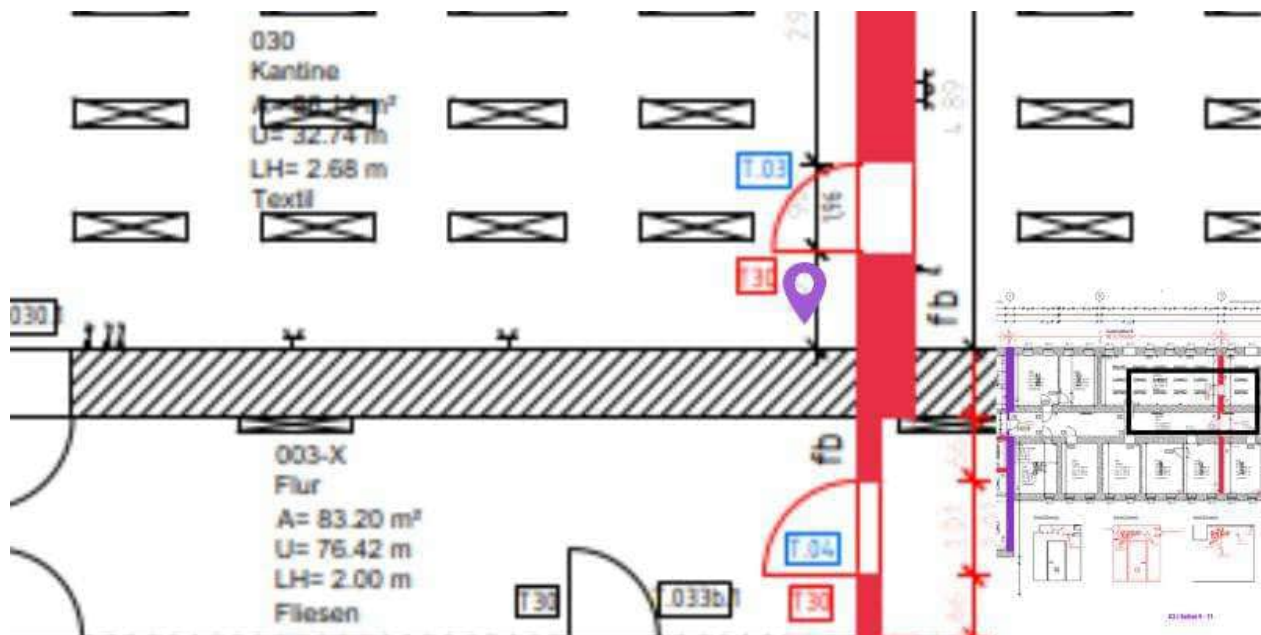

links sml, kann zurück gebaut werden
Rechts TW mit Dämmung
25.06.2025

Pin #11 – 030_2

Kategorie: Bestandsaufnahme
Status: Offen

Plan: 03_Achse 9-11 V1
Ersteller: Erich Bucker / 25.06.2025 09:15

bäudeteil B
3: 316.62m²

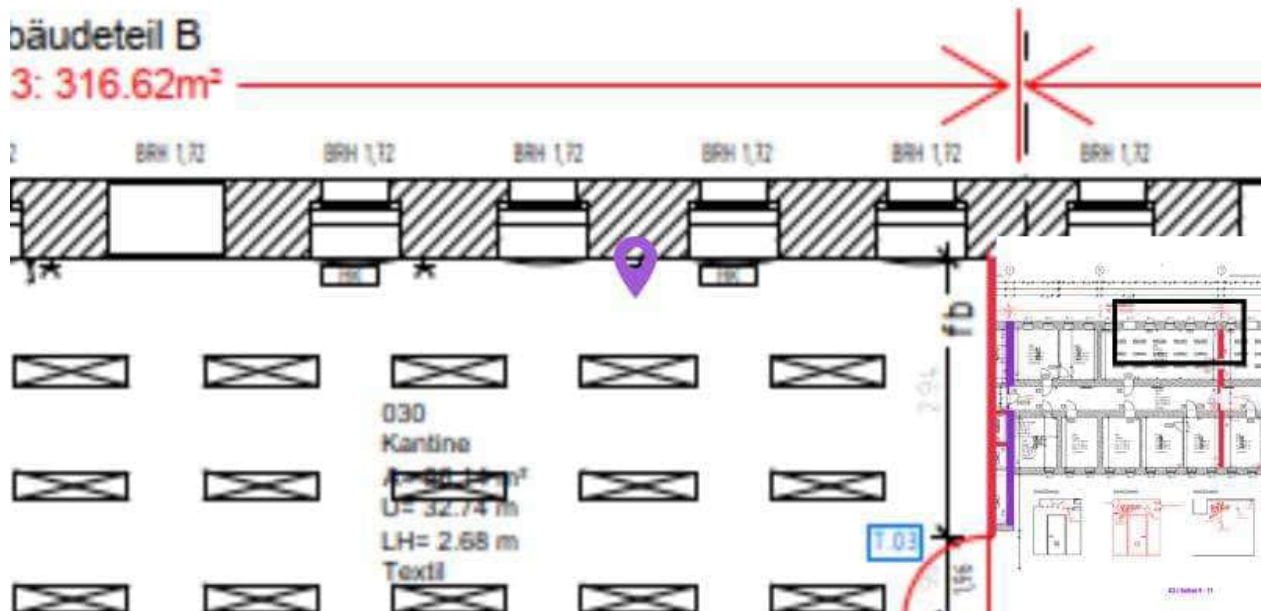

Pin #12 – 030_3

Kategorie: Bestandsaufnahme
Status: Offen

Plan: 03_Achse 9-11 V1
Ersteller: Erich Bucker / 25.06.2025 09:16

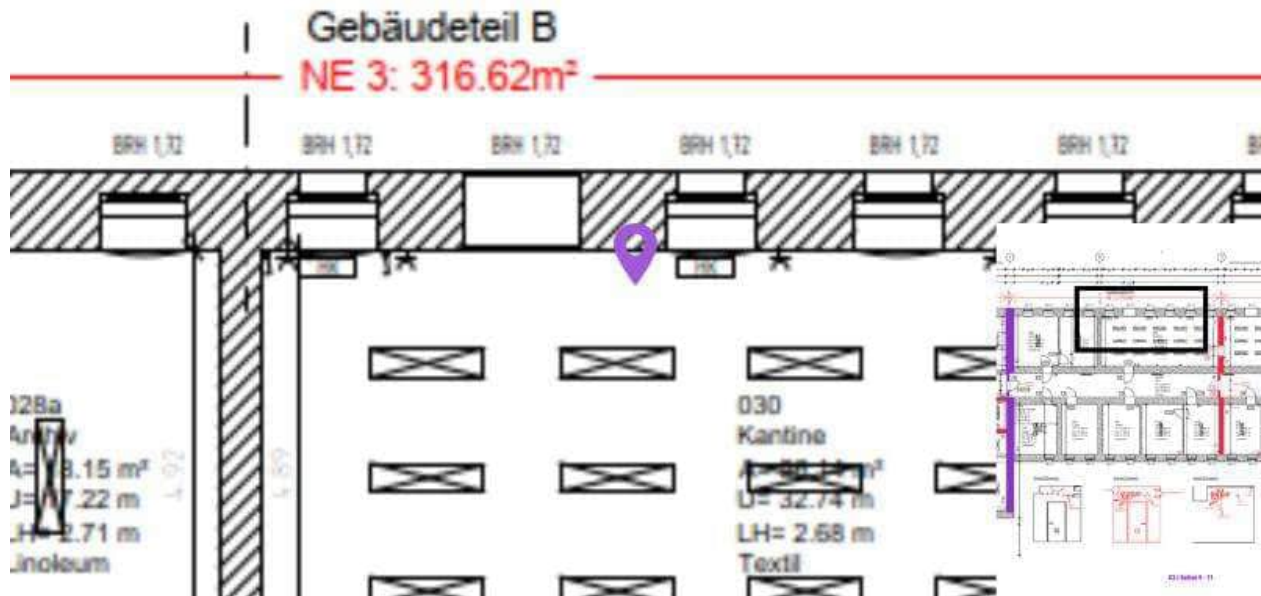

Pin #13 – 030_4

Kategorie: Bestandsaufnahme
Status: Offen

Plan: 03_Achse 9-11 V1
Ersteller: Erich Bucker / 25.06.2025 09:16

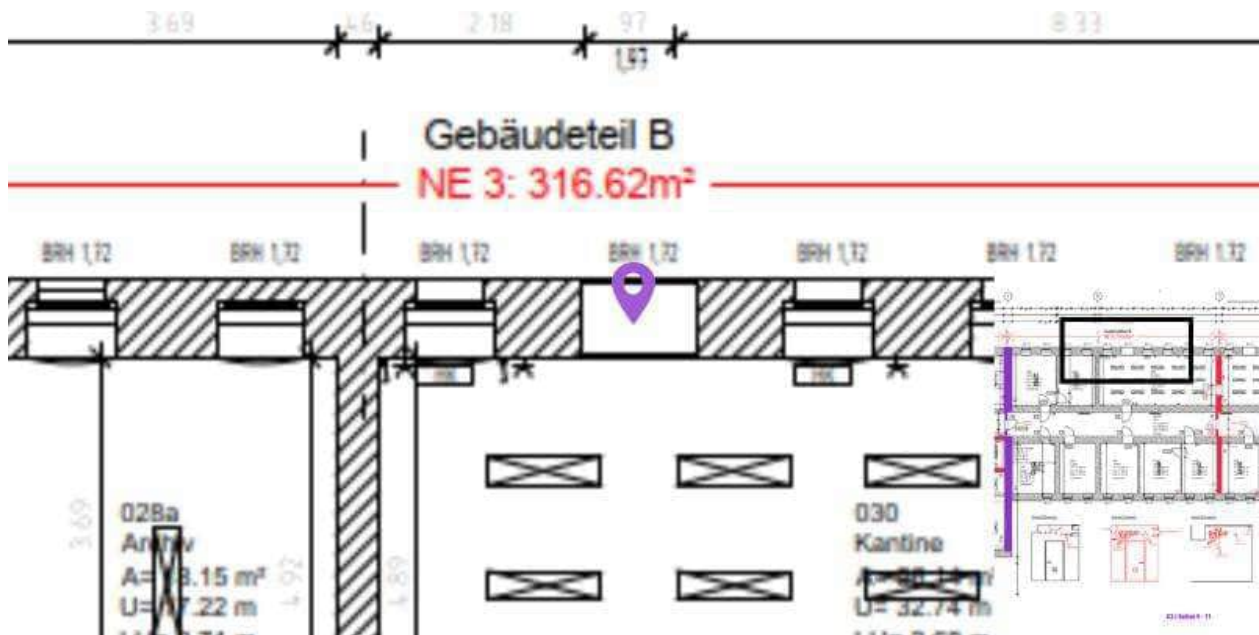

Pin #14 – 030_5

Kategorie: Bestandsaufnahme
Status: Offen

Plan: 03_Achse 9-11 V1
Ersteller: Erich Bucker / 25.06.2025 09:17

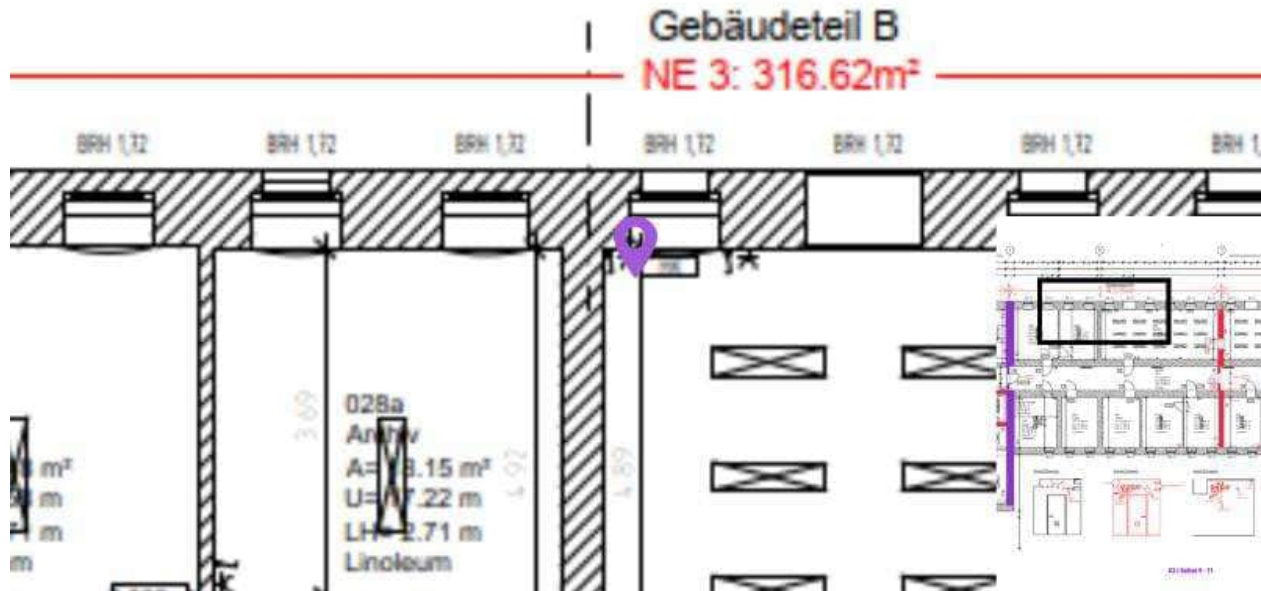

Pin #57 – 033a

Kategorie: Bestandsaufnahme
Status: Offen

Plan: 03_Achse 9-11 V1
Ersteller: Erich Bucker / 05.07.2025 22:09



Pin #58 – 033b

Kategorie: Bestandsaufnahme
Status: Offen

Plan: 03_Achse 9-11 V1
Ersteller: Erich Bucker / 05.07.2025 22:09

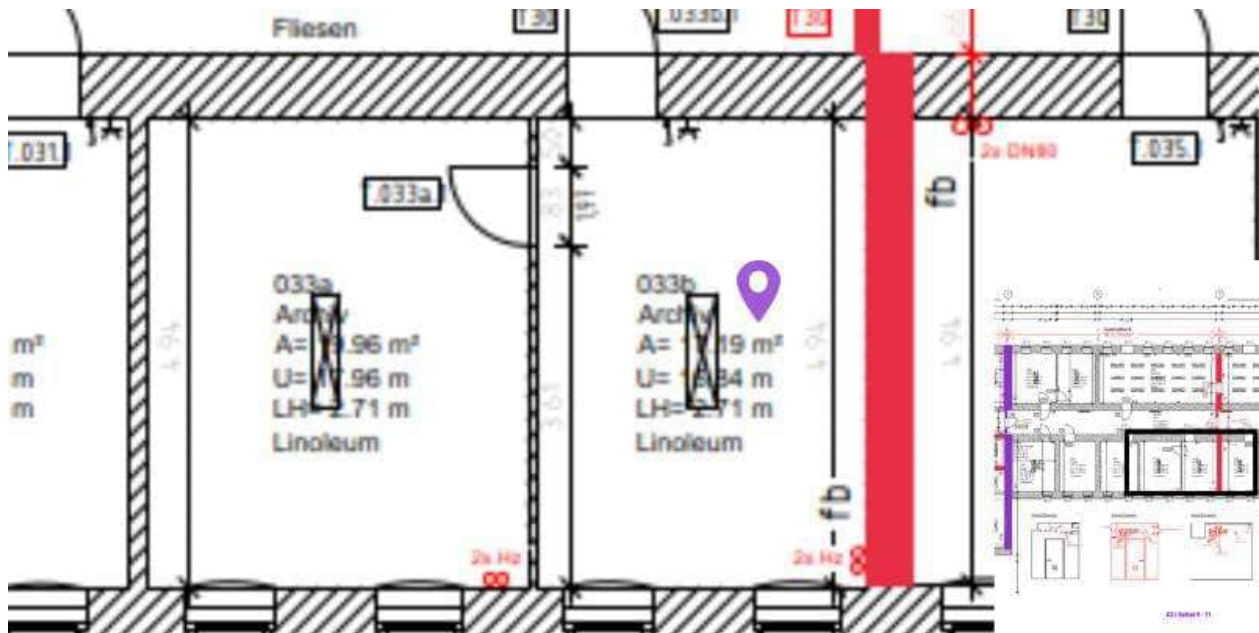

Pin #59 – 003-X Flur NE3-4

Kategorie: Bestandsaufnahme
Status: Offen

Plan: 03_Achse 9-11 V1
Ersteller: Erich Bucker / 05.07.2025 22:11

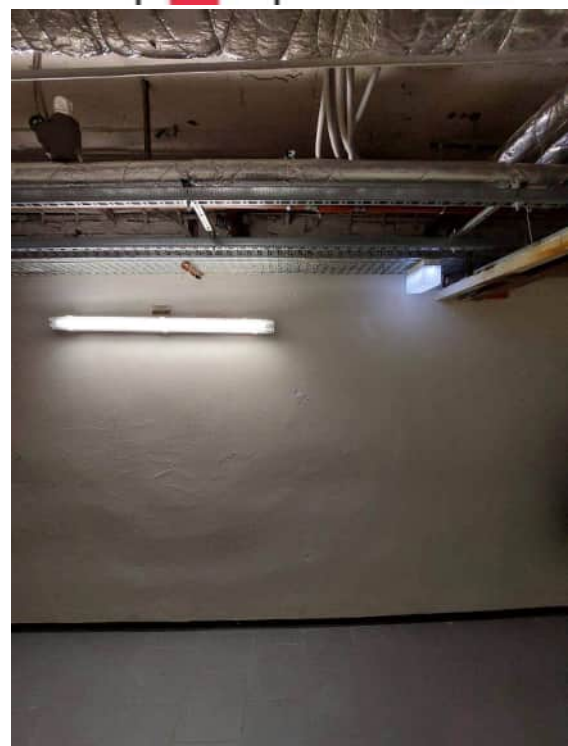
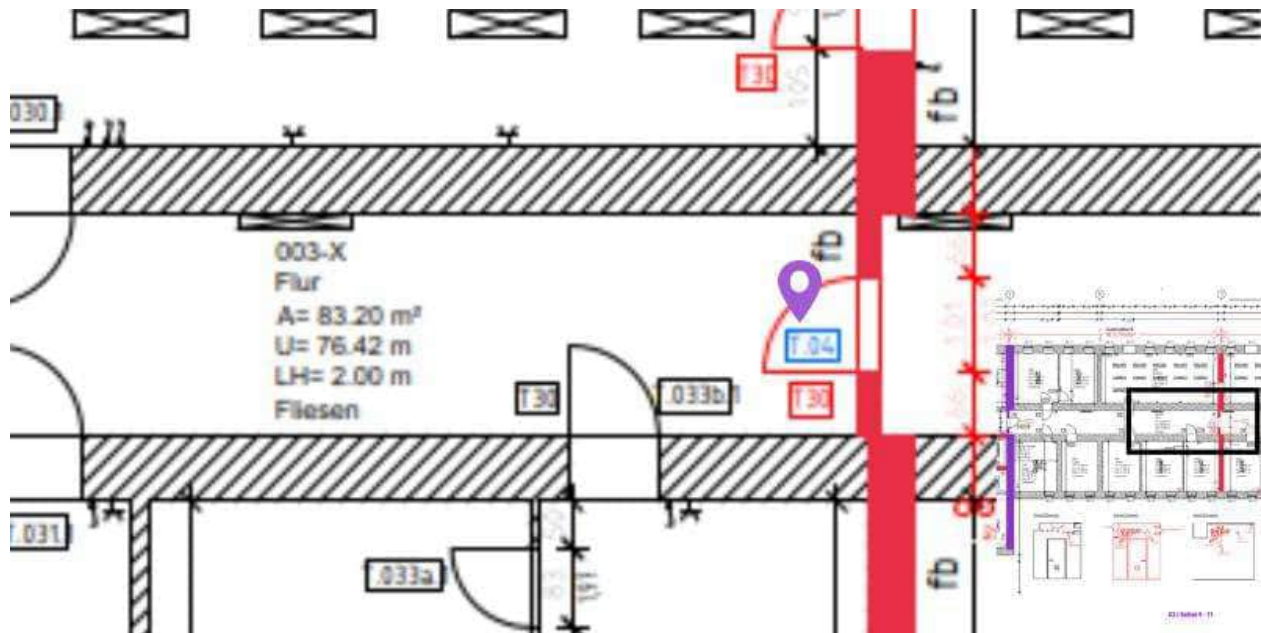



LP2_Fotodokumentation Achse 13-16

Projekt: 2024A070_Rheinfalallee 82
Brandschutzsanierung KG
Rheinfalallee 82, 10318 Berlin, DE

Bauherr: Bundesanstalt für Immobilienaufgaben
Fasanenstraße 87
10623 Berlin
Facility Management
BEFM.10318
Herr Sebastian Maier

Planung: KLW Ingenieure GmbH
Epiphanienweg 6
14059 Berlin

Ersteller: Erich Bückner
Datum: 09.01.2026

Inhaltsverzeichnis

05_Achse 13-16	3
<i>Pin #27 – 002c_X</i>	4
<i>Pin #28 – 001c-X_1</i>	5
<i>Pin #29 – 001c-X_2</i>	6
<i>Pin #32 – 001c-X_3</i>	9
<i>Pin #33 – 043</i>	10
<i>Pin #63 – 037</i>	11
<i>Pin #64 – 039b</i>	14
<i>Pin #65 – 039</i>	16
<i>Pin #66 – 001c</i>	18
<i>Pin #67 – 038</i>	19
<i>Pin #68 – 001b-X</i>	22
<i>Pin #69 – 041</i>	24
<i>Pin #70 – 001a-X</i>	27
<i>Pin #71 – 046</i>	29
<i>Pin #72 – 015-X</i>	31

Pin #27 – 002c_X

Kategorie: Bestandsaufnahme
Status: Offen

Plan: 05_Achse 13-16 V1
Ersteller: Erich Bucker / 25.06.2025 09:51

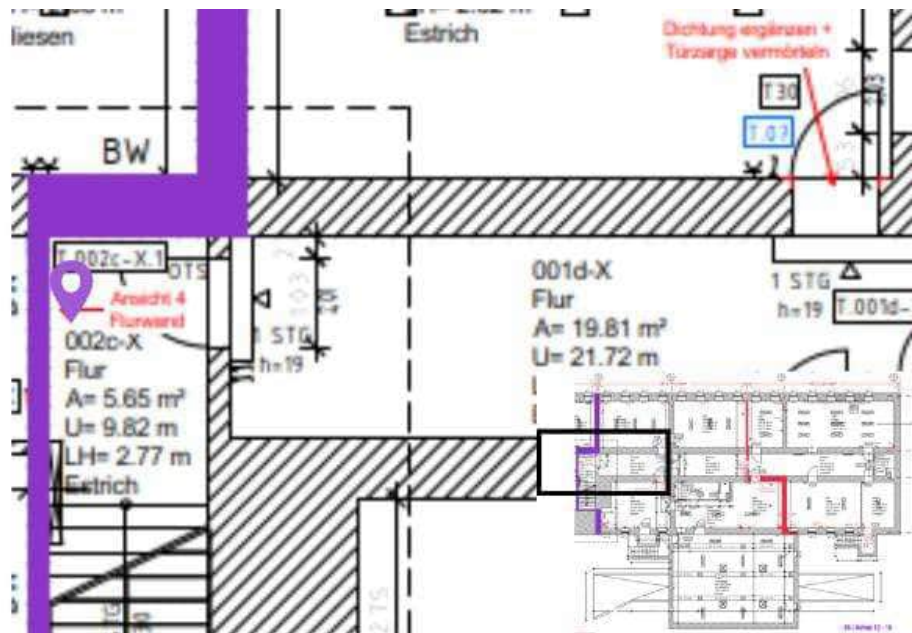

Pin #28 – 001c-X_1

Kategorie: Bestandsaufnahme
Status: Offen

Plan: 05_Achse 13-16 V1
Ersteller: Erich Bucker / 25.06.2025 09:54

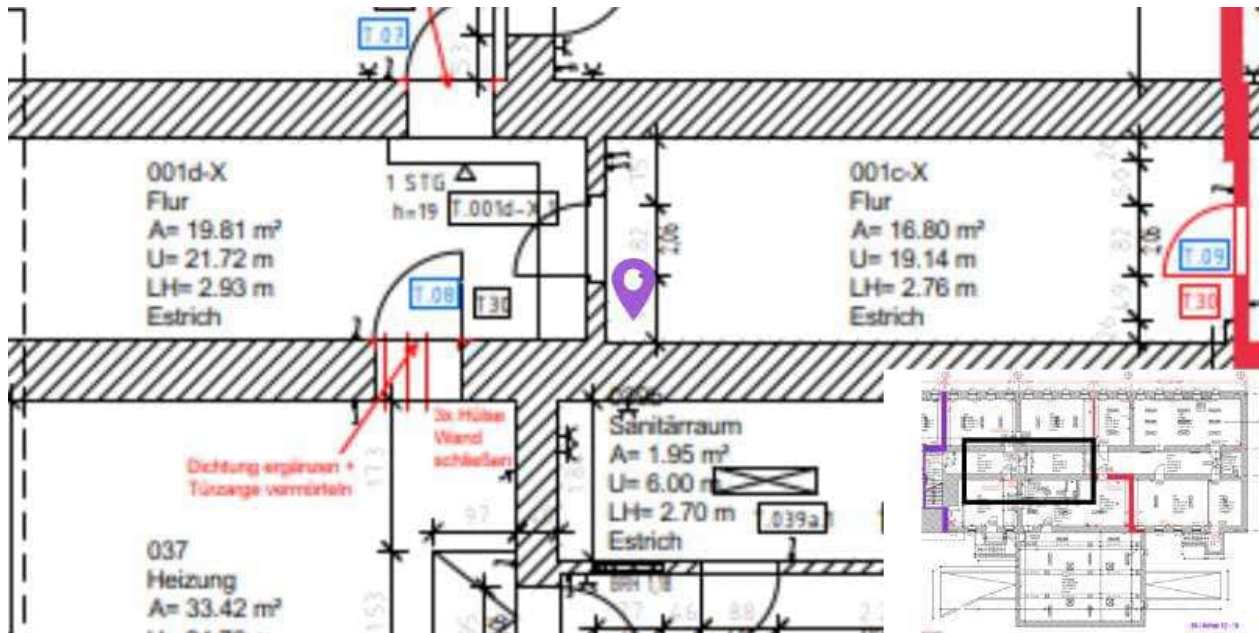





Pin #32 – 001c-X_3

Kategorie: Bestandsaufnahme
Status: Offen

Plan: 05_Achse 13-16 V1
Ersteller: Erich Bucker / 03.07.2025 23:41

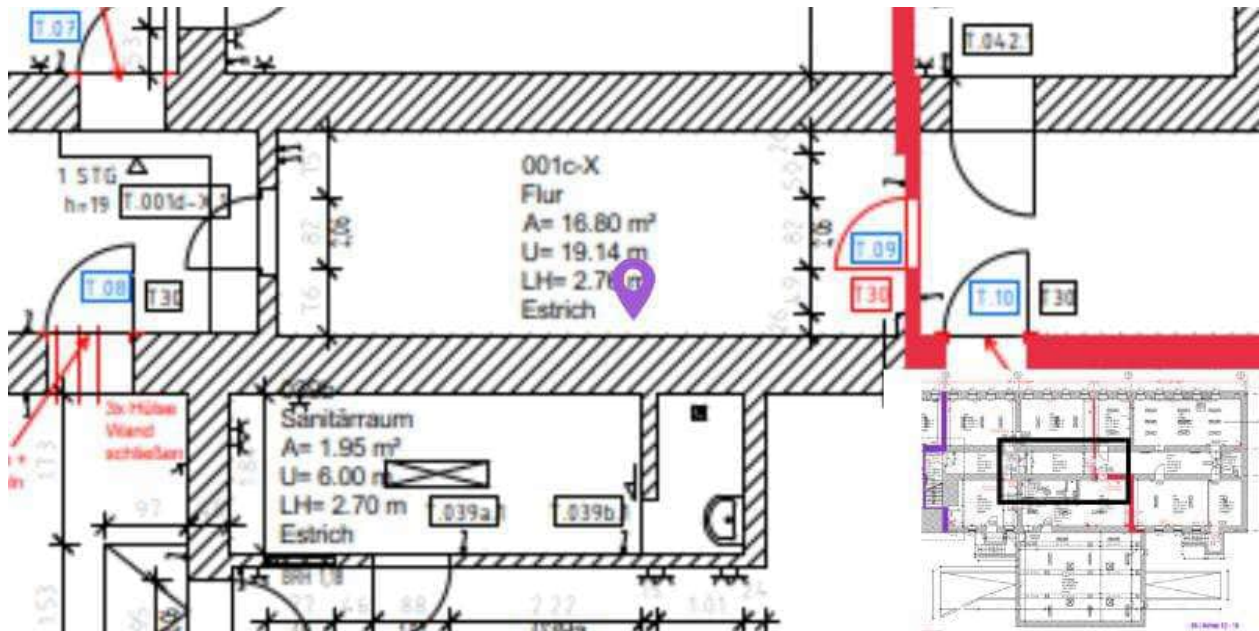

Pin #33 – 043

Kategorie: Bestandsaufnahme
Status: Offen

Plan: 05_Achse 13-16 V1
Ersteller: Erich Bucker / 03.07.2025 23:52

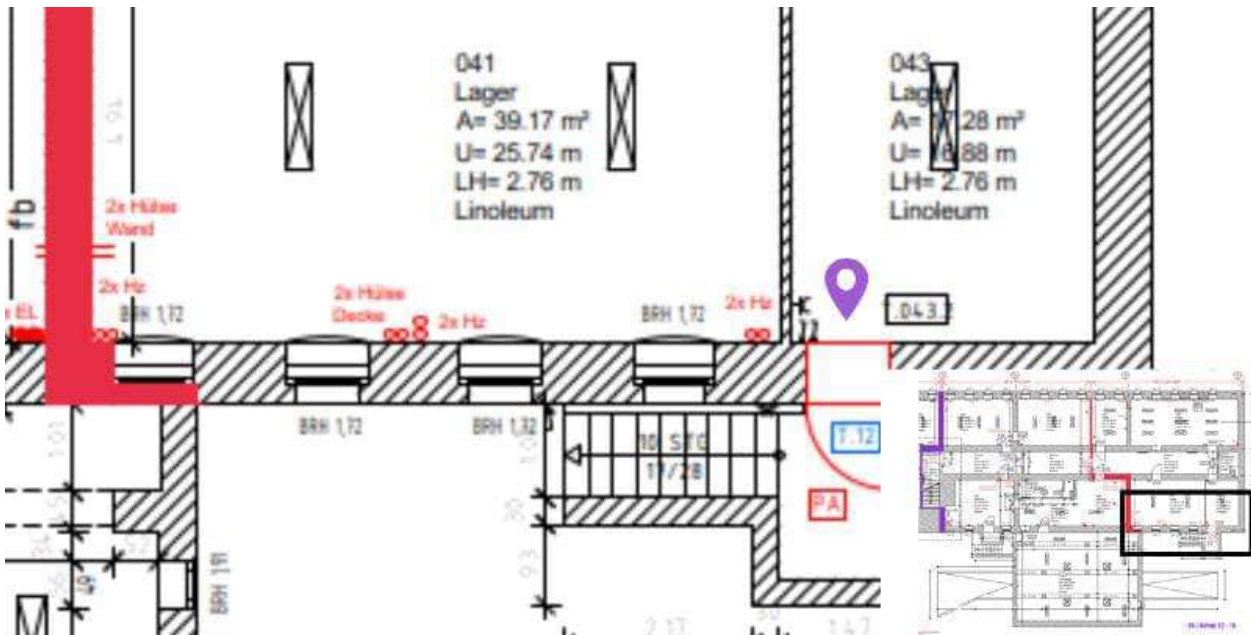

Pin #63 – 037

Kategorie: Bestandsaufnahme
Status: Offen

Plan: 05_Achse 13-16 V1
Ersteller: Erich Bucker / 05.07.2025 22:46

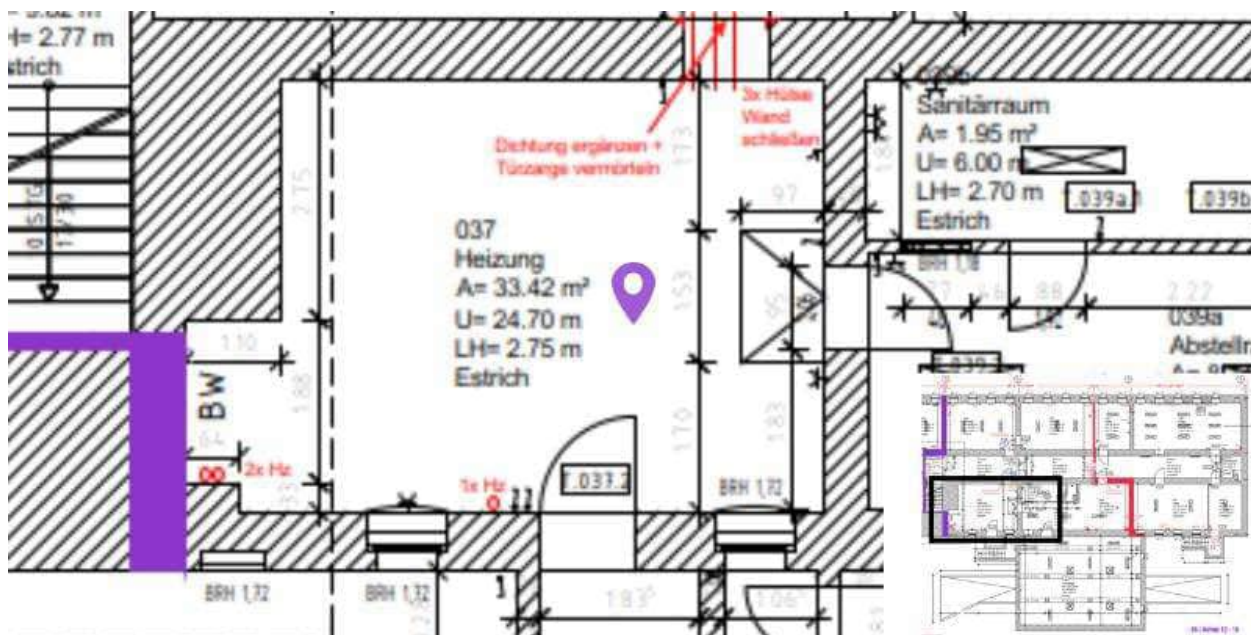

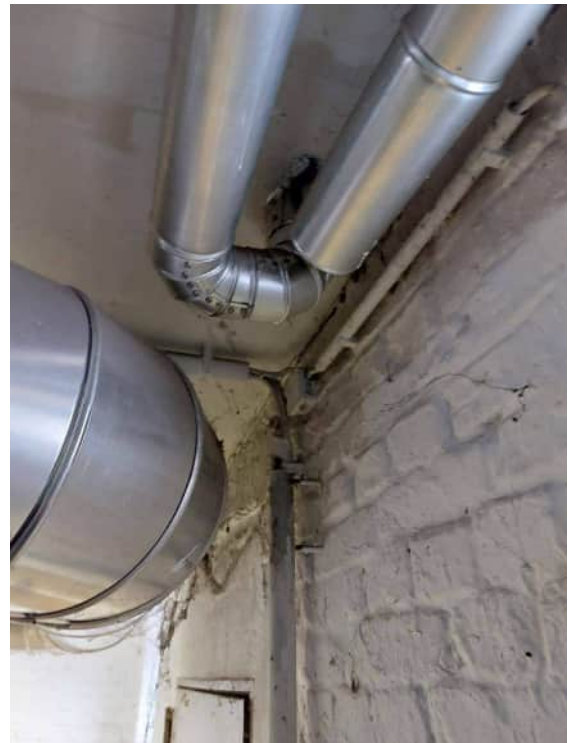



Pin #64 – 039b

Kategorie: Bestandsaufnahme
Status: Offen

Plan: 05_Achse 13-16 V1
Ersteller: Erich Bucker / 05.07.2025 22:53

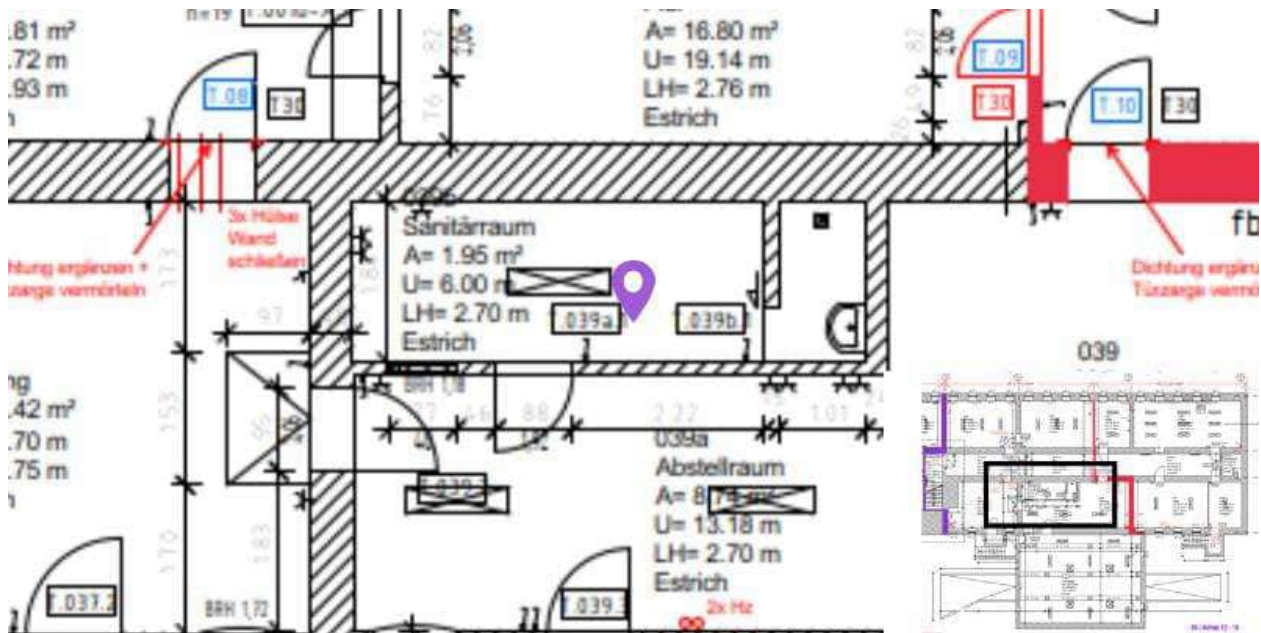



Pin #65 – 039

Kategorie: Bestandsaufnahme
Status: Offen

Plan: 05_Achse 13-16 V1
Ersteller: Erich Bucker / 05.07.2025 22:56

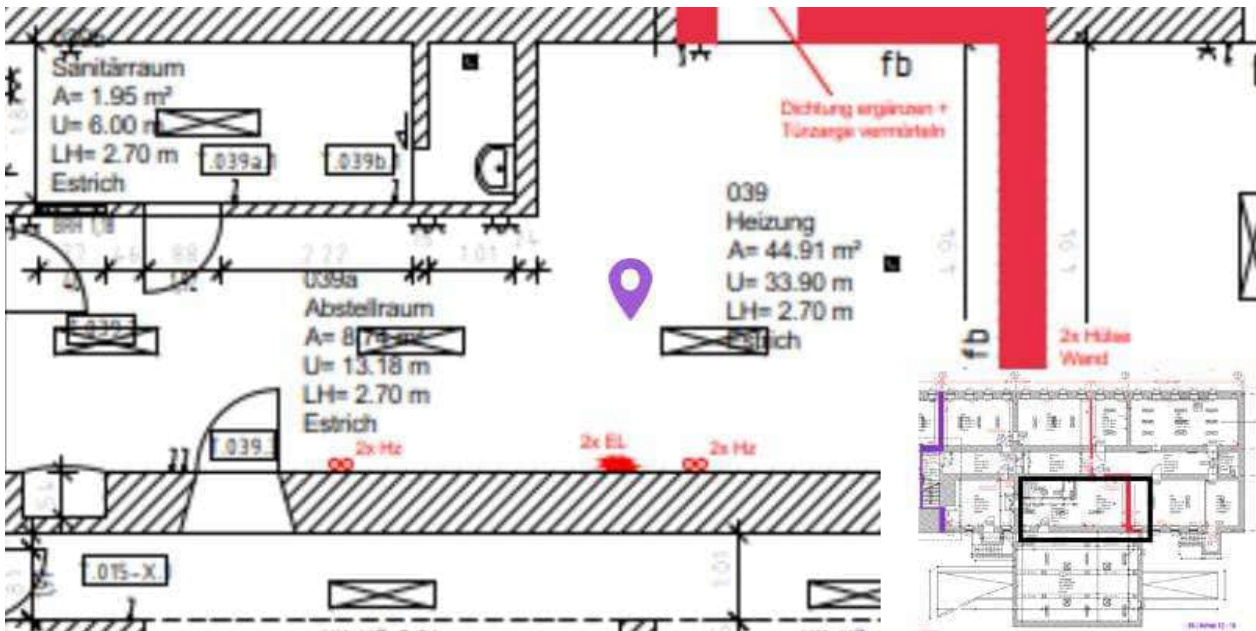



Pin #66 – 001c

Kategorie: Bestandsaufnahme
Status: Offen

Plan: 05_Achse 13-16 V1
Ersteller: Erich Bucker / 05.07.2025 22:59

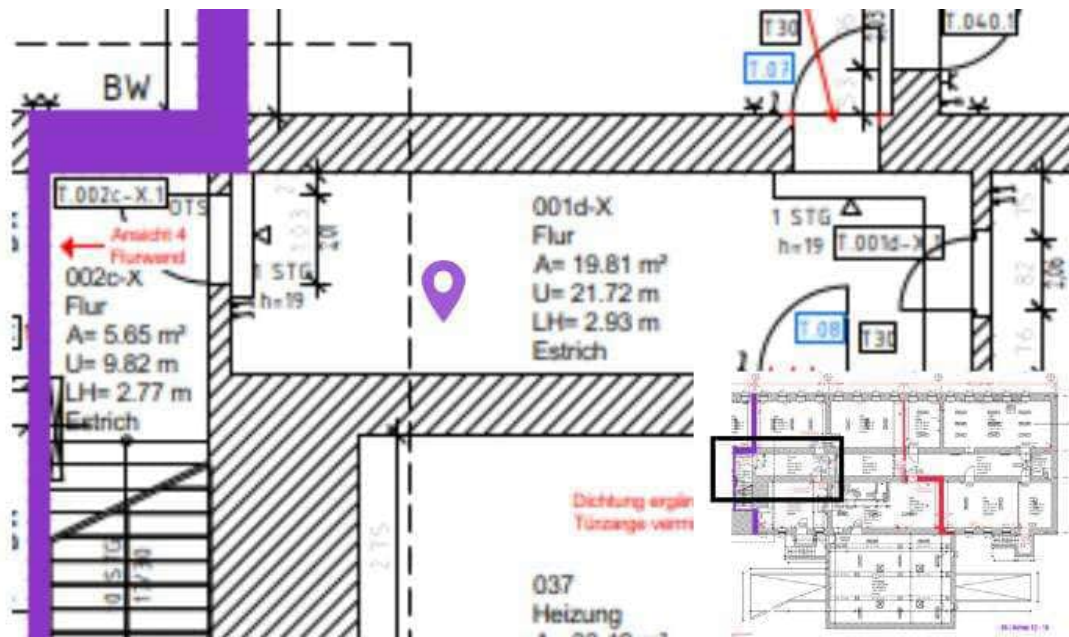

Pin #67 – 038

Kategorie: Bestandsaufnahme
Status: Offen

Plan: 05_Achse 13-16 V1
Ersteller: Erich Bucker / 05.07.2025 23:03









Pin #69 – 041

Kategorie: Bestandsaufnahme
Status: Offen

Plan: 05_Achse 13-16 V1
Ersteller: Erich Bucker / 05.07.2025 23:08

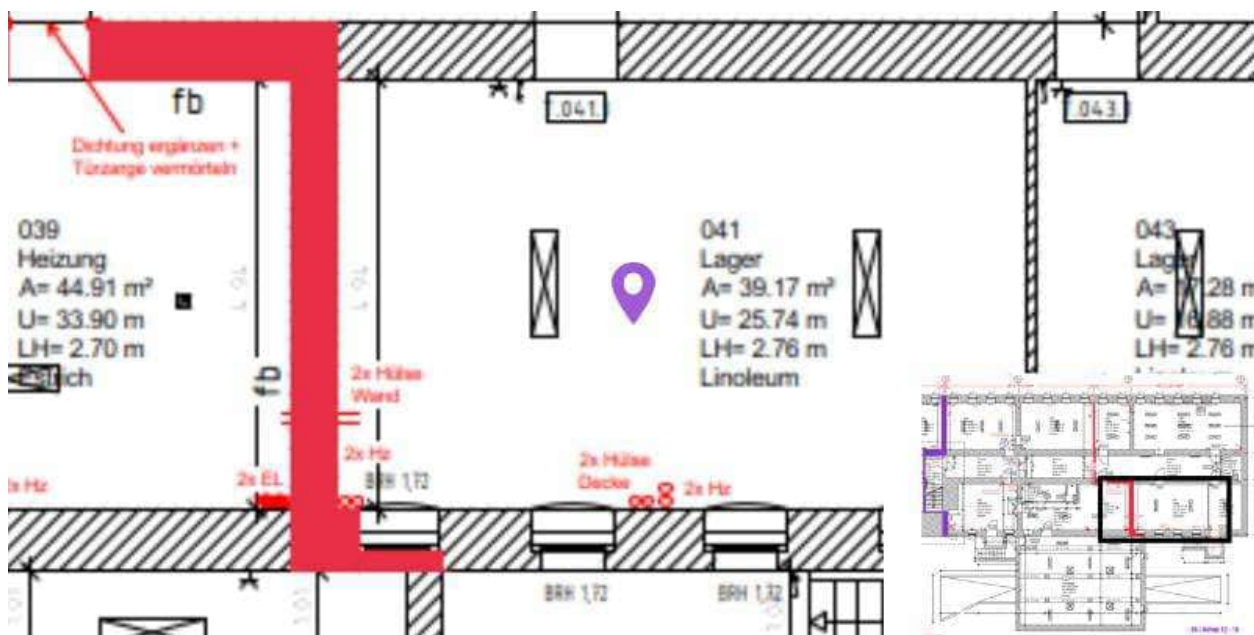

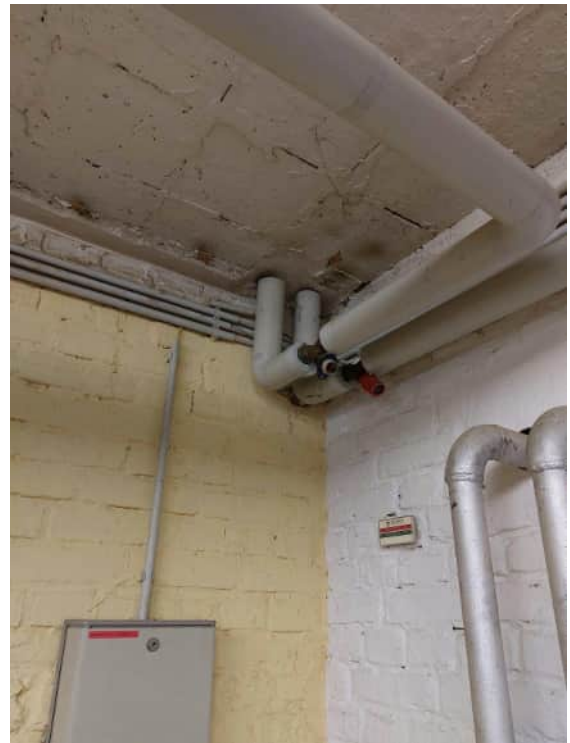
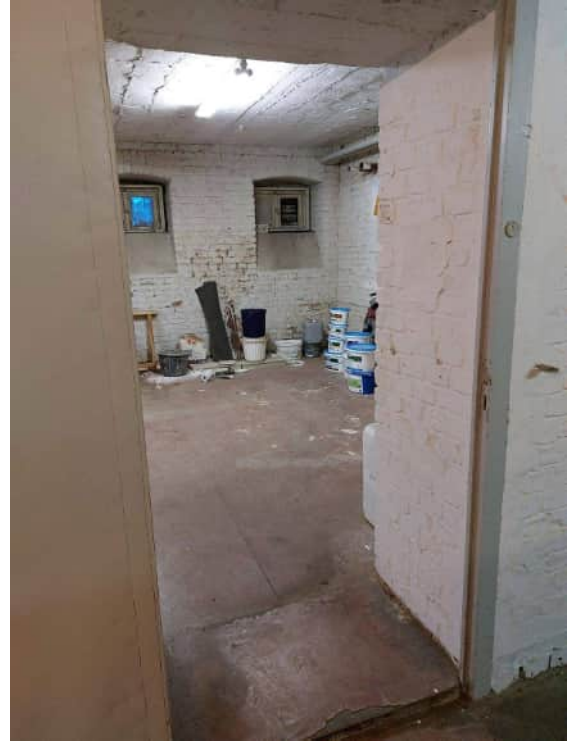



Die oberen Bilder sind falsch 05.07.25 / 23:10
02.12.2025

Pin #70 – 001a-X

Kategorie: Bestandsaufnahme
Status: Offen

Plan: 05_Achse 13-16 V1
Ersteller: Erich Bucker / 05.07.2025 23:13

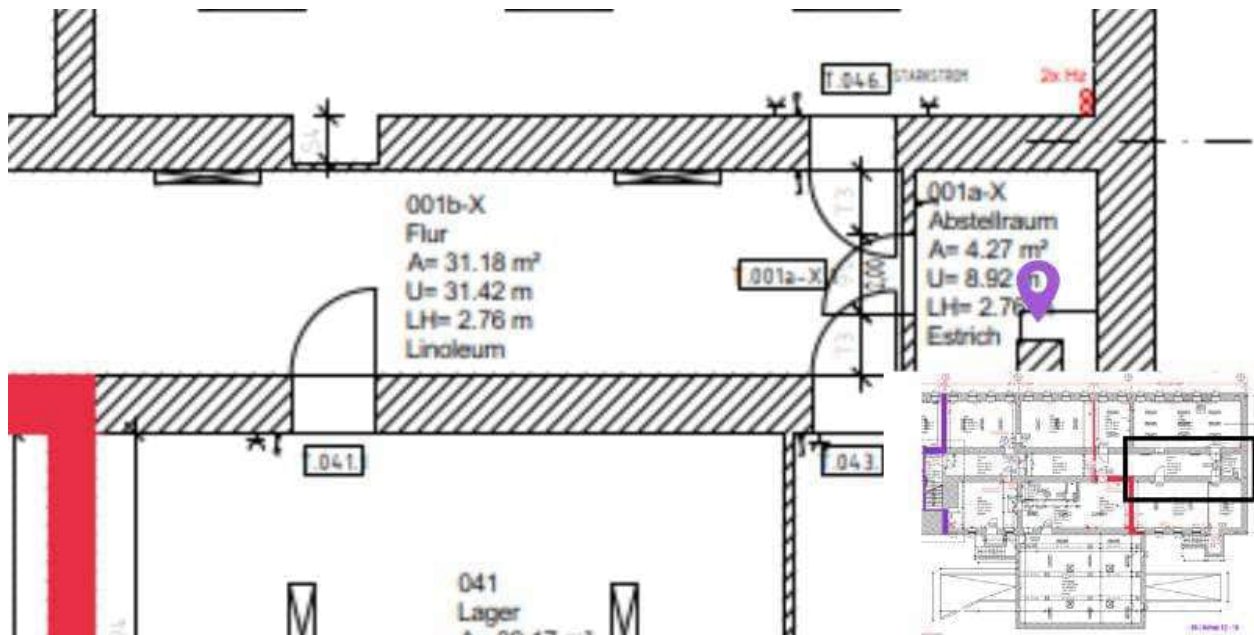

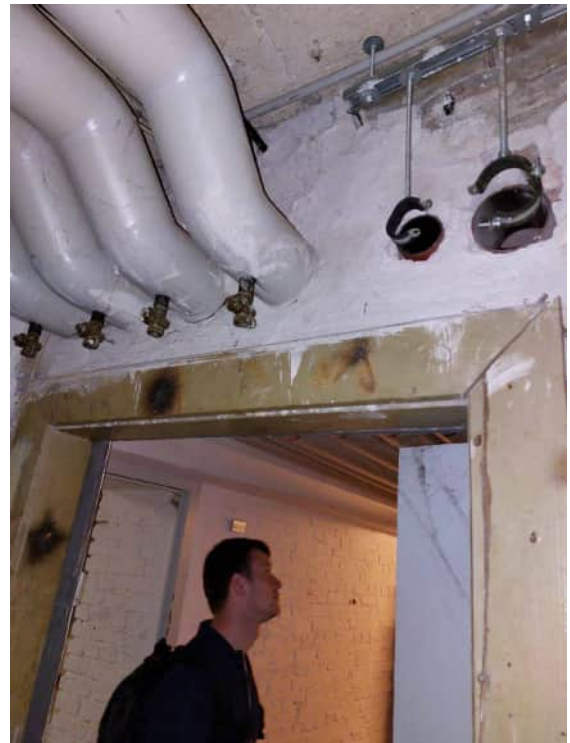

Pin #71 – 046

Kategorie: Bestandsaufnahme
Status: Offen

Plan: 05_Achse 13-16 V1
Ersteller: Erich Bucker / 05.07.2025 23:14

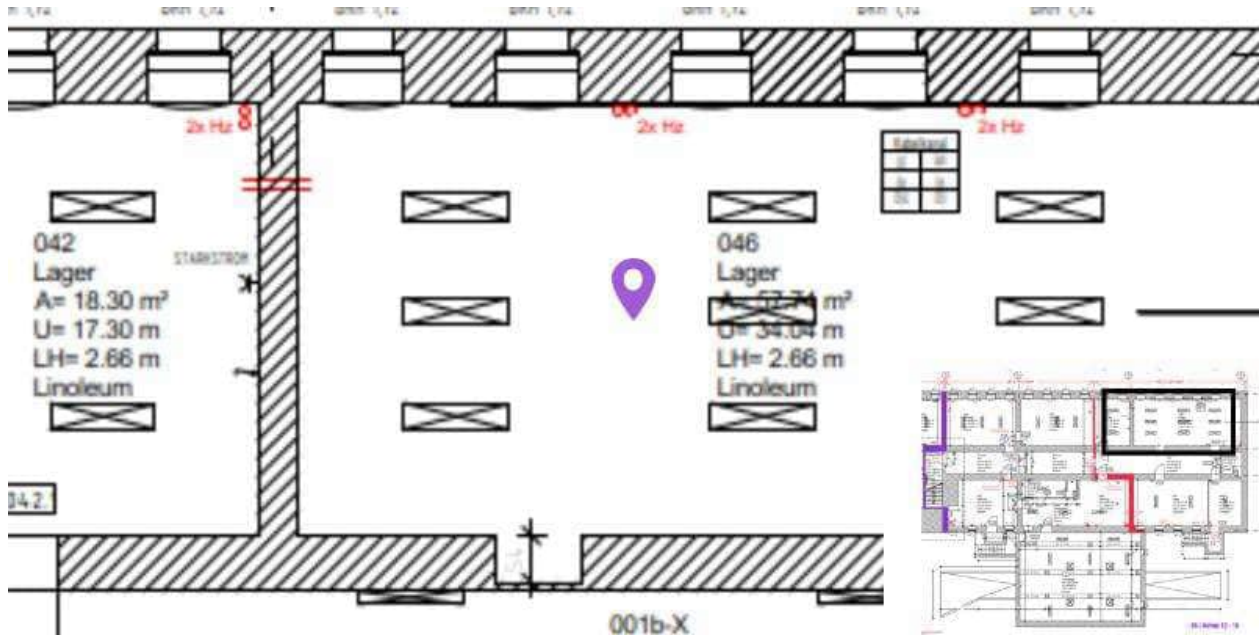



Pin #72 – 015-X

Kategorie: Bestandsaufnahme
Status: Offen

Plan: 05_Achse 13-16 V1
Ersteller: Erich Bucker / 05.07.2025 23:20

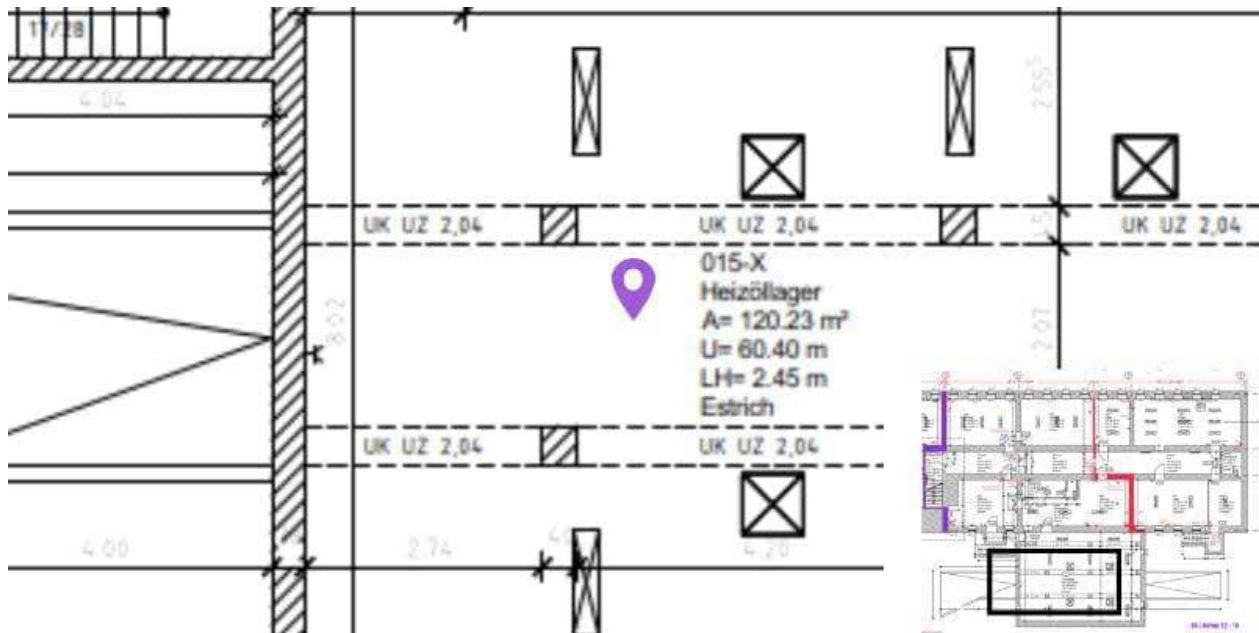

LP2_Fotodokumentation Achse 11-13

Projekt: 2024A070_Rheinfalzallee 82
Brandschutzsanierung KG
Rheinfalzallee 82, 10318 Berlin, DE

Bauherr: Bundesanstalt für Immobilienaufgaben
Fasanenstraße 87
10623 Berlin
Facility Management
BEFM.10318
Herr Sebastian Maier

Planung: KLW Ingenieure GmbH
Epiphanienweg 6
14059 Berlin

Ersteller: Erich Bückner
Datum: 09.01.2026

Inhaltsverzeichnis

04_Achse 11-13	3
<i>Pin #17 – 032_2</i>	4
<i>Pin #18 – 032_3</i>	5
<i>Pin #19 – 032_4</i>	6
<i>Pin #20 – 032_5</i>	7
<i>Pin #21 – 034a_1</i>	8
<i>Pin #22 – 034a_2</i>	10
<i>Pin #24 – 034a_3</i>	11
<i>Pin #25 – 034a_4</i>	12
<i>Pin #26 – 0002a</i>	13

Pin #17 – 032_2

Kategorie: Bestandsaufnahme
Status: Offen

Plan: 04_Achse 11-13 V1
Ersteller: Erich Bucker / 25.06.2025 09:28

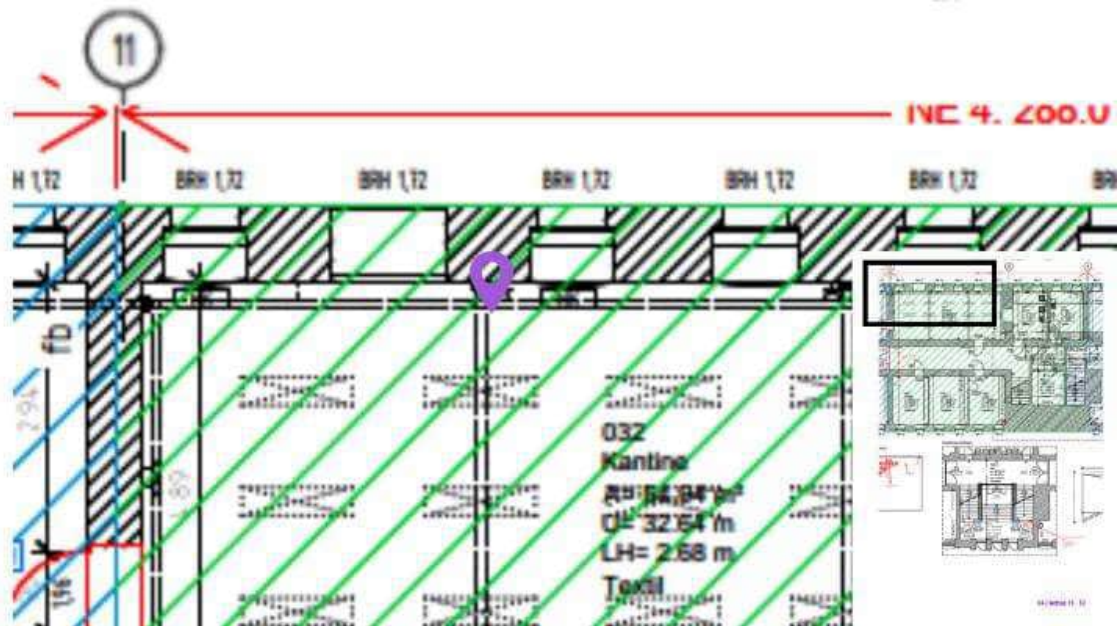

Pin #18 – 032_3

Kategorie: Bestandsaufnahme
Status: Offen

Plan: 04_Achse 11-13 V1
Ersteller: Erich Bucker / 25.06.2025 09:28

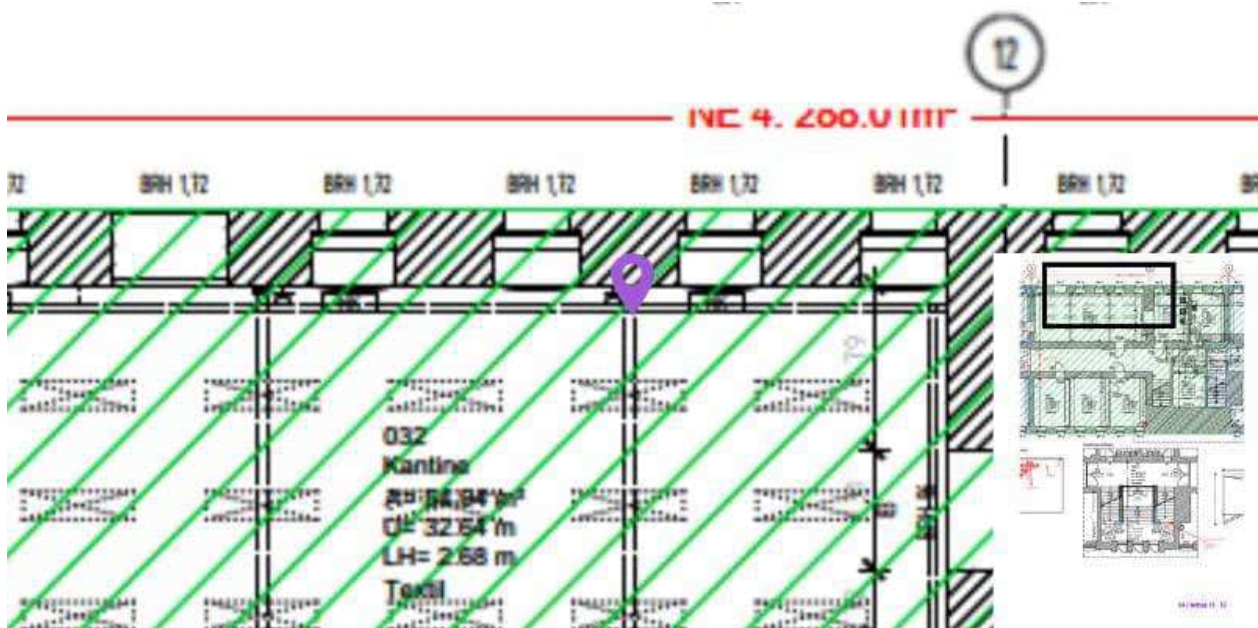

Pin #19 – 032_4

Kategorie: Bestandsaufnahme
Status: Offen

Plan: 04_Achse 11-13 V1
Ersteller: Erich Bucker / 25.06.2025 09:29

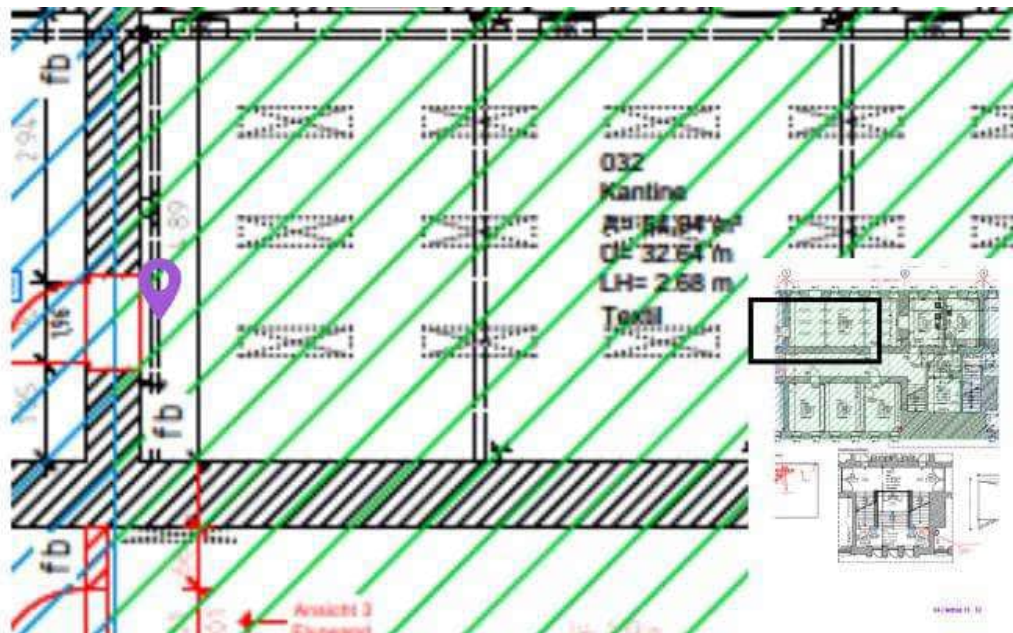

Pin #20 – 032_5

Kategorie: Bestandsaufnahme
Status: Offen

Plan: 04_Achse 11-13 V1
Ersteller: Erich Bucker / 25.06.2025 09:29

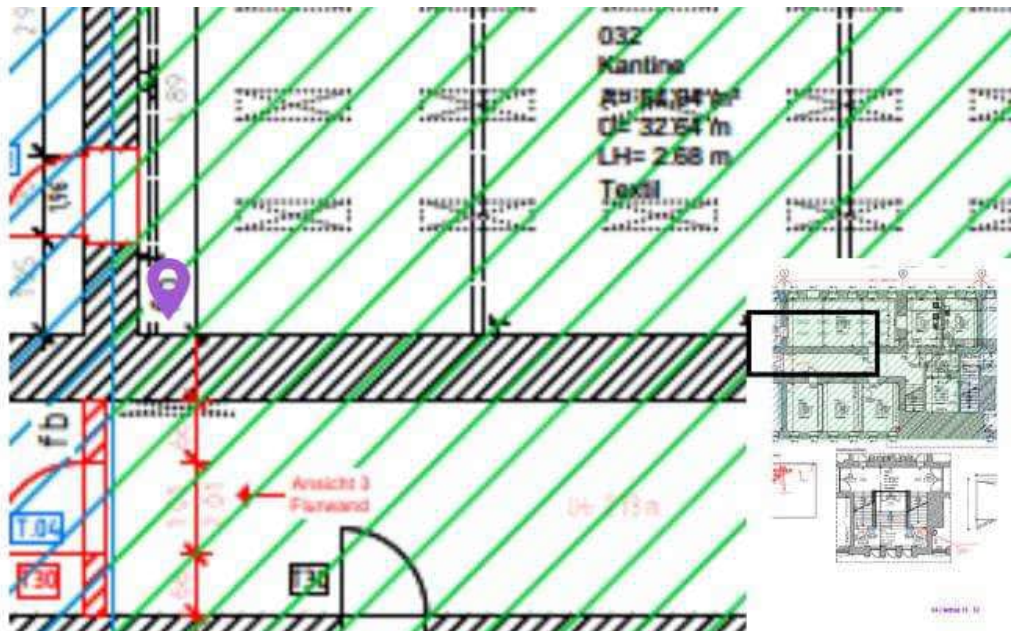

Pin #21 – 034a_1

Kategorie: Bestandsaufnahme
Status: Offen

Plan: 04_Achse 11-13 V1
Ersteller: Erich Bucker / 25.06.2025 09:32

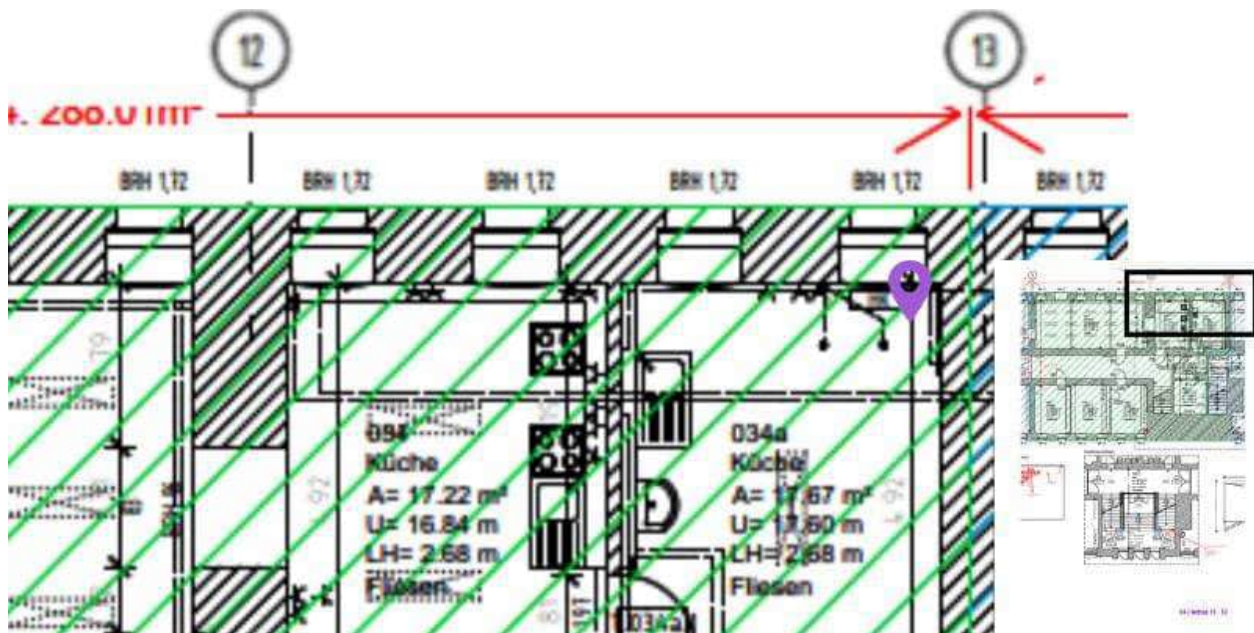



Pin #22 – 034a_2

Kategorie: Bestandsaufnahme
Status: Offen

Plan: 04_Achse 11-13 V1
Ersteller: Erich Bucker / 25.06.2025 09:35

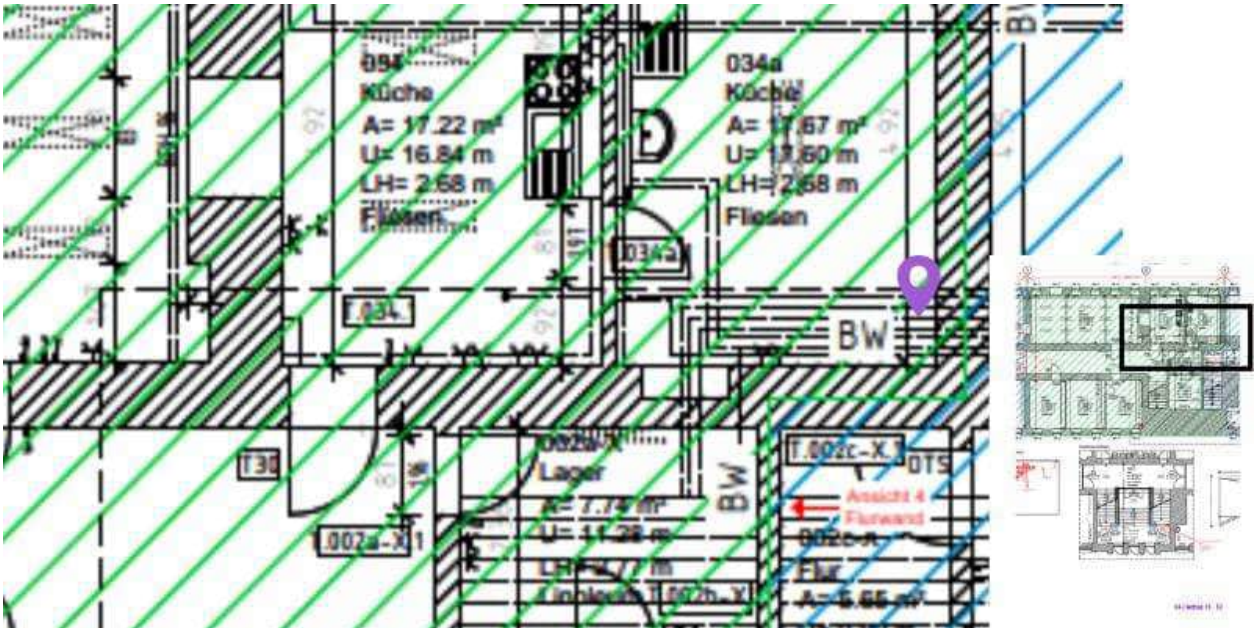

Pin #24 – 034a_3

Kategorie: Bestandsaufnahme
Status: Offen

Plan: 04_Achse 11-13 V1
Ersteller: Erich Bucker / 25.06.2025 09:38

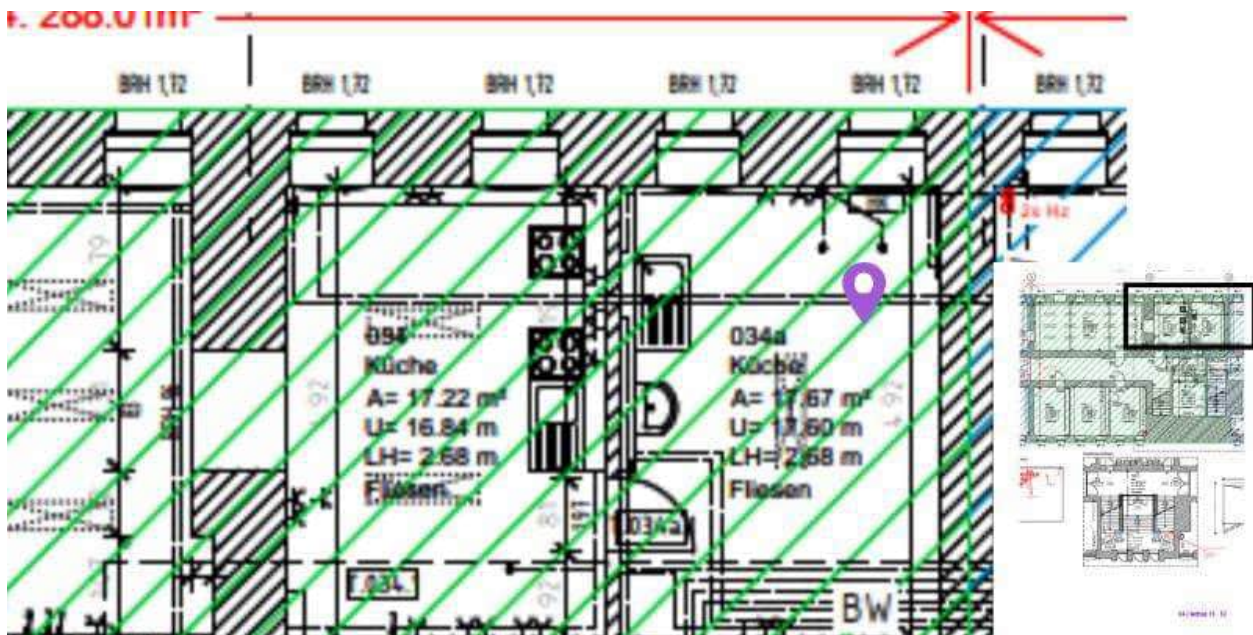

Pin #25 – 034a_4

Kategorie: Bestandsaufnahme
Status: Offen

Plan: 04_Achse 11-13 V1
Ersteller: Erich Bucker / 25.06.2025 09:39



weiße Leitung Trockensteigeleitung

25.06.2025



Pin #26 – 0002a

Kategorie: Bestandsaufnahme
Status: Offen

Plan: 04_Achse 11-13 V1
Ersteller: Erich Bucker / 25.06.2025 09:44

